

**Elementi a giorno** pag. 3  
Open units

**Accessori per cassetti** pag. 11  
Accessories for drawers depth. 50

**Pattumiere** pag. 27  
Waste bins

**Luci** pag. 44  
Lights

**Accessori sottopensili** pag. 50  
Under wall unit accessories

**Piedi penisola** pag. 57  
Peninsula feet

**Accessori per mensola** pag. 58  
Shelf accessories

**Ripiani** pag. 60  
Shelves

**Cerniere** pag. 61  
Hinges

**Accessori vari** pag. 63  
Various accessories



## ELEMENTI A GIORNO IN POLIMERICICO

POLYMERIC OPEN UNITS



colori disponibili per elementi a giorno polimerici opachi  
available colours for matt polymeric open units

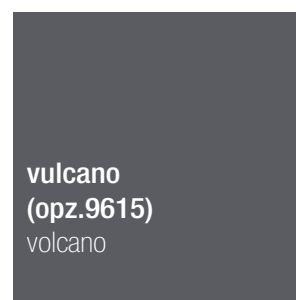
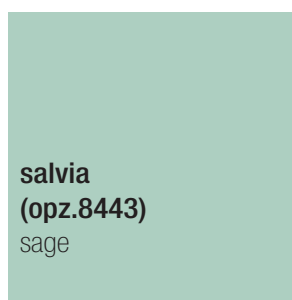
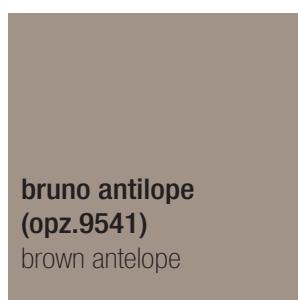

# ELEMENTI A GIORNO

## OPEN UNITS

### elementi pensili orizzontali chiusi

wall units elements horizontal closed

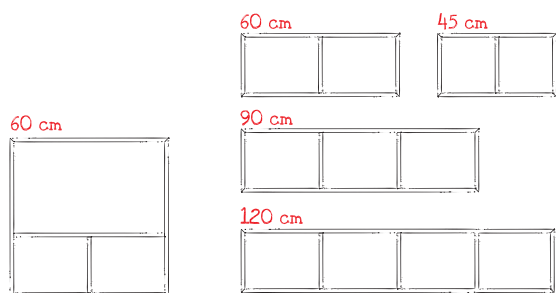

### elementi pensili orizzontali aperti sopra

wall units elements horizontal open on top

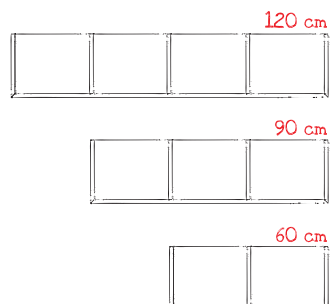

### elementi pensili verticali

wall units elements vertical

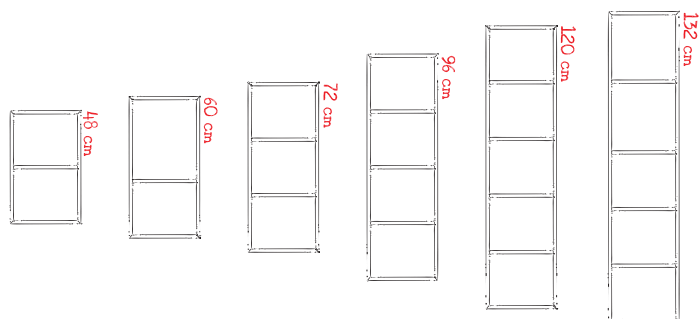

### elementi per basi e colonne

elements for base units and columns

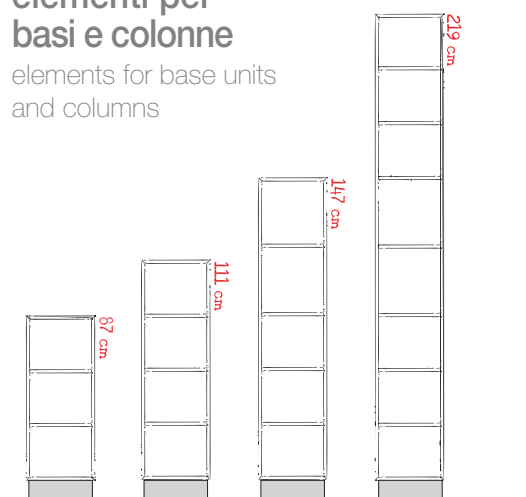





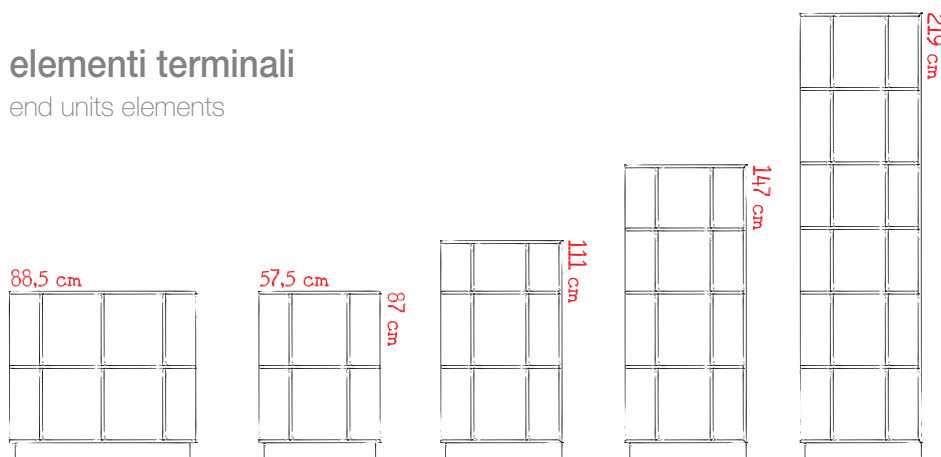

### elementi terminali

end units elements







**ELEMENTI A GIORNO IN POLIMERICO STRUTTURA SP.14 MM**  
**POLYMERIC OPEN UNITS STRUCTURE TH. 14 MM**

	<p><b>pensile H 24 a giorno con 2 vani attaccaglie a scomparsa</b></p>	<p>open wall unit H 24 with 2 compartments concealed hangers</p>	<p><b>CODICE / CODE No.</b></p>	
	<p><b>L 45 H 24 P 31</b> <b>L 60 H 24 P 31</b></p>	<p>W 45 H 24 D 31 W 60 H 24 D 31</p>	<p>E7700705 E7700706</p>	
	<p><b>pensile H 24 a giorno con 3 vani attaccaglie a scomparsa</b></p>	<p>open wall unit H 24 with 3 compartments concealed hangers</p>		
	<p><b>pensile H 24 a giorno con 4 vani attaccaglie a scomparsa</b></p>	<p>open wall unit H 24 with 4 compartments concealed hangers</p>		
	<p><b>pensile H 24 a giorno aperto sopra con 2 vani attaccaglie a scomparsa</b></p>	<p>top open wall unit H 24 with 2 compartments concealed hangers</p>		
	<p><b>pensile H 24 a giorno aperto sopra con 3 vani attaccaglie a scomparsa</b></p>	<p>top open wall unit H 24 with 3 compartments concealed hangers</p>		
	<p><b>pensile H 24 a giorno aperto sopra con 4 vani attaccaglie a scomparsa</b></p>	<p>top open wall unit H 24 with 4 compartments concealed hangers</p>		

# ELEMENTI A GIORNO IN POLIMERICO STRUTTURA SP.14 MM

POLYMERIC OPEN UNITS STRUCTURE TH. 14 MM





	<p>pensile H 36 a giorno con 1 vano attaccaglie a scomparsa</p> <p><b>L 30 H 36 P 31</b></p>	<p>open wall unit H 36 with 1 compartment concealed hangers</p> <p>W 30 H 36 D 31</p>	<p><b>CODICE / CODE No.</b></p> <p>E7700709</p>	
	<p>pensile H 36 a giorno con 2 vani attaccaglie a scomparsa</p> <p><b>L 45 H 36 P 31</b> <b>L 60 H 36 P 31</b></p>	<p>open wall unit H 36 with 2 compartments concealed hangers</p> <p>W 45 H 36 D 31 W 60 H 36 D 31</p>	<p>E7700710 E7700711</p>	
	<p>pensile H 36 a giorno con 3 vani attaccaglie a scomparsa</p> <p><b>L 90 H 36 P 31</b></p>	<p>open wall unit H 36 with 3 compartments concealed hangers</p> <p>W 90 H 36 D 31</p>	<p>E7700712</p>	
	<p>pensile H 36 a giorno con 4 vani attaccaglie a scomparsa</p> <p><b>L 120 H 36 P 31</b></p>	<p>open wall unit H 36 with 4 compartments concealed hangers</p> <p>W 120 H 36 D 31</p>	<p>E7700713</p>	
	<p>pensile H 60 a giorno con 3 vani attaccaglie a scomparsa</p> <p><b>L 60 H 60 P 31</b></p>	<p>open wall unit H 60 with 3 compartments concealed hangers</p> <p>W 60 H 60 D 31</p>	<p>E7700720</p>	

# ELEMENTI A GIORNO IN POLIMERICO STRUTTURA SP.14 MM

POLYMERIC OPEN UNITS STRUCTURE TH. 14 MM

	<p><b>pensile H 48 a giorno con 2 vani attaccaglie a scomparsa</b></p>	<p>open wall unit H 48 with 2 compartments concealed hangers</p>	<p><b><i>CODICE / CODE No.</i></b></p>	
	<p><b>pensile H 60 a giorno con 2 vani attaccaglie a scomparsa</b></p>	<p>open wall unit H 60 with 2 compartments concealed hangers</p>	<p>E7700732</p>	
	<p><b>pensile H 72 a giorno con 3 vani attaccaglie a scomparsa</b></p>	<p>open wall unit H 72 with 3 compartments concealed hangers</p>	<p>E7700733</p>	
	<p><b>pensile H 96 a giorno con 4 vani attaccaglie a scomparsa</b></p>	<p>open wall unit H 96 with 4 compartments concealed hangers</p>	<p>E7700734</p>	
	<p><b>pensile H 120 a giorno con 5 vani attaccaglie a scomparsa</b></p>	<p>open wall unit H 120 with 5 compartments concealed hangers</p>	<p>E7700735</p>	
	<p><b>pensile H 132 a giorno con 5 vani attaccaglie a scomparsa</b></p>	<p>open wall unit H 132 with 5 compartments concealed hangers</p>	<p>E7700736</p>	
			<p>E7700737</p>	



**ELEMENTI A GIORNO IN POLIMERICO STRUTTURA SP.14 MM**  
**POLYMERIC OPEN UNITS STRUCTURE TH. 14 MM**

	<p>base a giorno con 3 vani</p> <p>open base unit with 3 compartments</p> <p><b>L 30 H 87 P 31</b></p>	<p><b>CODICE / CODE No.</b></p> <p>E7700750</p>	
	<p>colonna a giorno con 4 vani</p> <p>open column with 4 compartments</p> <p><b>L 30 H 111 P 31</b></p>	<p>E7700760</p>	
	<p>colonna a giorno con 5 vani</p> <p>open column with 5 compartments</p> <p><b>L 30 H 147 P 31</b></p>	<p>E7700765</p>	
	<p>colonna a giorno con 8 vani</p> <p>open column with 8 compartments</p> <p><b>L 30 H 219 P 31</b></p>	<p>E7700767</p>	



# ELEMENTI A GIORNO IN POLIMERICO STRUTTURA SP.14 MM

## POLYMERIC OPEN UNITS STRUCTURE TH. 14 MM

 <p>disegno verso sx LH version drawing</p>	<p><b>terminale base con 6 vani</b></p> <p>end base unit with 6 compartments</p> <p><b>L 30 H 87 P 57,5 DX</b> <b>L 30 H 87 P 57,5 SX</b></p> <p>W 30 H 87 D 57,5 RH W 30 H 87 D 57,5 LH</p>	<p><b>CODICE / CODE No.</b></p> <p>E7700801 E7700802</p>	
	<p><b>terminale penisola con 6 vani</b></p> <p>peninsula end unit with 6 compartments</p> <p><b>L 30 H 87 P 57,5</b></p> <p>W 30 H 87 D 57,5</p>	<p>E7700810</p>	
	<p><b>terminale penisola con 8 vani</b></p> <p>peninsula end unit with 8 compartments</p> <p><b>L 30 H 87 P 88,5</b></p> <p>W 30 H 87 D 88,5</p>	<p>E7700820</p>	
 <p>disegno verso sx LH version drawing</p>	<p><b>terminale colonna con 9 vani</b></p> <p>column end unit with 9 compartments</p> <p><b>L 30 H 111 P 57,5 DX</b> <b>L 30 H 111 P 57,5 SX</b></p> <p>W 30 H 111 D 57,5 RH W 30 H 111 D 57,5 LH</p>	<p>E7700921 E7700922</p>	
 <p>disegno verso sx LH version drawing</p>	<p><b>terminale colonna con 12 vani</b></p> <p>column end unit with 12 compartments</p> <p><b>L 30 H 147 P 57,5 DX</b> <b>L 30 H 147 P 57,5 SX</b></p> <p>W 30 H 147 D 57,5 RH W 30 H 147 D 57,5 LH</p>	<p>E7700931 E7700932</p>	
 <p>disegno verso sx LH version drawing</p>	<p><b>terminale colonna con 18 vani</b></p> <p>column end unit with 18 compartments</p> <p><b>L 30 H 219 P 57,5 DX</b> <b>L 30 H 219 P 57,5 SX</b></p> <p>W 30 H 219 D 57,5 RH W 30 H 219 D 57,5 LH</p>	<p>E7700941 E7700942</p>	







# ACCESSORI PER CASSETTI Prof. 50

ACCESSORIES FOR DRAWERS DEPT. 50

	<p><b>Portaposate in plastica per cassetto (di serie)</b> Plastic cutlery tray for drawer (standard size)</p>	<p>L 30 L 40 L 45</p>	<p><b>CODICE / CODE No.</b></p> <p>08700030X 08700040X 08700050X</p>	
	<p><b>Portaposate in plastica per cassetto 60 (di serie)</b> Plastic cutlery tray for drawer 60 (standard size)</p>	<p>L 60</p>	<p>08700060X</p>	
<p>L 45                      L 60</p>	<p><b>Portaposate in plastica con divisori regolabili (a richiesta)</b> Plastic cutlery tray with adjustable partitions (on request)</p>	<p>L 45 L 60</p>	<p>08700065X 08700068X</p>	
<p>L 90</p>	<p><b>Portaposate in plastica con divisori regolabili (a richiesta)</b> Plastic cutlery tray with adjustable partitions (on request)</p>	<p>L 90</p>	<p>08700070X</p>	
	<p><b>Tappetino in gomma antiscivolo per cassetto</b> Non-slip rubber drawer mat</p>	<p>L 30 L 40 L 45 L 60 L 90</p>	<p>08700148X 08700149X 08700150X 08700160X 08700170X</p>	

**ACCESSORI PER CASSETTI Prof. 50**

ACCESSORIES FOR DRAWERS DEPT. 50

	<b>104.00</b> <b>Portaposate in faggio</b> Beech cutlery tray	<i>CODICE / CODE No.</i>	
	<b>cassetto da 45</b> drawer 45	<b>08707590</b>	
	<b>104.01</b> <b>Portaposate in faggio</b> Beech cutlery tray		
	<b>cassetto da 60</b> drawer 60	<b>08707591</b>	
	<b>104.02</b> <b>Portaposate in faggio con portaspezie</b> Beech cutlery tray with spice holder		
	<b>cassetto da 60</b> drawer 60	<b>08707592</b>	
	<b>104.03</b> <b>Portaposate in faggio con portacoltelli</b> Beech cutlery tray with knife rack		
	<b>cassetto da 60</b> drawer 60	<b>08707593</b>	
	<b>104.04</b> <b>Portaposate in faggio con portaspezie e portacoltelli</b> Beech cutlery tray with spice holder and knife rack		
	<b>cassetto da 90</b> drawer 90	<b>08707594</b>	

**ACCESSORI PER CASSETTI Prof. 50**

ACCESSORIES FOR DRAWERS DEPT. 50

 <p><b>104.06</b> <b>Portapadelle con colonnine color faggio</b> Pan holder with beech colour small columns</p> <p><b>per cestone H 36-48 da 60</b> for 60 cm deep drawer H36-48</p>	<b>CODICE / CODE No.</b>	
 <p><b>104.07</b> <b>Portapadelle con colonnine color faggio</b> Pan holder with beech colour small columns</p> <p><b>per cestone H 36-48 da 90</b> for 90 cm deep drawer H36-48</p>	<b>08707596</b>	
 <p><b>104.08</b> <b>Portapiatti color faggio</b> Plate holder, beech colour</p> <p><b>per cestone H 48 da 60</b> for 60 cm deep drawer H48</p>	<b>08707597</b>	
 <p><b>104.09</b> <b>Portapiatti color faggio</b> Plate holder, beech colour</p> <p><b>per cestone H 48 da 90</b> for 90 cm deep drawer H48</p>	<b>08707598</b>	
	<b>08707599</b>	

# elle tipi

La linea portaposate in legno WOOD EXCLUSIVE viene prodotta in frassino olivato o noce. Brevettata, ha un design unico ed è un complemento di prestigio per ogni cucina

This cutlery holders product line is made of WOOD EXCLUSIVE ashwood or walnut. It is a patented, unique design which brings real luxury to any kitchen.

Линия деревянных лотков для столовых приборов WOOD EXCLUSIVE изготовлена из ясеня или ореха. Эта запатентованная линия с уникальным дизайном станет роскошным дополнением любой кухни.



## Wood Esclusivo

JUST BLUM TANDEMBOX

### Caratteristiche:

1. Realizzato in frassino olivato o noce completamente riciclabile.
2. Disponibile per cassetti da 400-1200 mm.
3. Divisori portaposate con un spessore di 10 mm.
4. Disponibile nelle finiture frassino olivato naturale o noce scuro.
5. Disponibili accessori particolari come porta coltelli, porta spezie a tre piani, porta spezie con 8 contenitori in vetro e porta pellicola.
6. Vernici eco sostenibili e certificate per alimentari.
7. Facile da pulire.

### Features:

1. Made out of olive ash white pigmented and walnut transparent lacquered completely recyclable.
2. Available for of 400-1200 mm drawers.
3. 10 mm. thick cutlery holder dividers.
4. Available in olive ash white pigmented or walnut transparent lacquered.
5. Special accessories available such as a like knife holder, spice rack with three levels, spice rack with 8 glass containers and a cling film holder.
6. Painted with environmentally sustainable paint and certified for food.
7. Easy to clean.

### Характеристики:

1. Лотки изготовлены из ясеня или ореха, полностью подлежащего вторичной переработке.
2. Имеются модели для ящиков от 400 до 1200 мм.
3. Разделители толщиной 10 мм.
4. Имеются следующие виды отделки: натуральный ясень или темный орех.
5. Возможность дополнения следующими принадлежностями: отсеком для хранения ножей, трехуровневым держателем для специй, держателем для специй с 8 стеклянными емкостями и держателем для полиэтиленовой пленки.
6. Экологичные и сертифицированные для контакта с пищевыми продуктами лаки.
7. Легкость очистки.



# Wood Exclusive



Porta coltelli  
*Knife block*  
Отсек для хранения ножей



Contentori in vetro porta spezie  
*Spice rack glass containers*  
Стеклянные емкости для специй



Porta pellicola  
*Cling film holder*  
Держатель для полиэтиленовой пленки



Scomparti porta spezie  
*Compartments for spices*  
Отсеки для специй





Noce - Walnut - Opex

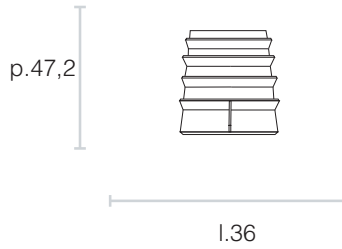
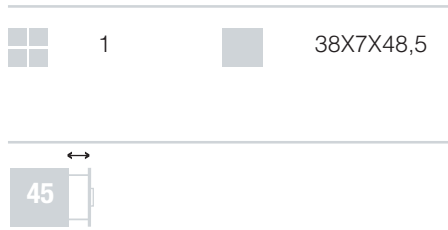

Cod. 08708600 Frassino olivato - Olive ash - Ясень

PLB C50045 BLT18

Noce - Walnut - Opex

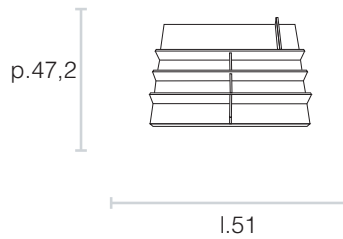

Cod. 08708601 Frassino olivato - Olive ash - Ясень

PLB C50060 BLT18

Noce - Walnut - Opex

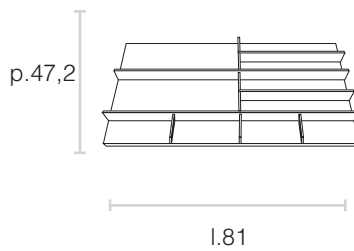
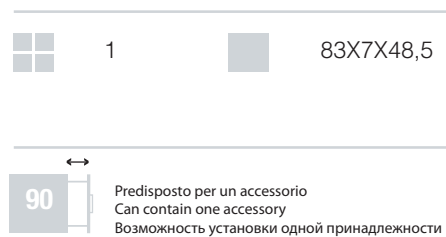

Cod. 08708602 Frassino olivato - Olive ash - Ясень

PLB C50090 BLT18

Noce - Walnut - Opex

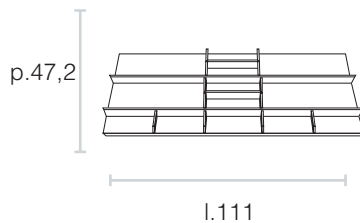

Cod. 08708603 Frassino olivato - Olive ash - Ясень

PLB C50120 BLT18



**PLB FPS3**  
**PLB CPS3**

Scoparti porta spezie  
 Compartments for spices  
 Отсеки для специй

Cod. 08708606



**PLB FPP**  
**PLB CPP**

Porta pellicole  
 Cling film holder  
 Держатель для полиэтиленовой пленки

Cod. 08708608



**PLB FPC**  
**PLB CPC**

Porta coltelli  
 Knife block  
 Отсек для хранения ножей

Cod. 08708605



**PLB FPS8**  
**PLB CPS8**

8 Contenitori in vetro porta spezie  
 Spice rack glass containers  
 8 Стеклянные емкости для специй

Cod. 08708607

OPTIONALS

# elleipini

La linea di portaposate in legno WOOD SLIMLINE viene prodotta in MDF verniciato bianco.

I divisori sottili ed il design minimale rendono questo prodotto unico nel suo genere.

The cutlery tray line SLIMLINE WOOD is made out of white painted MDF.

The thin dividers and minimalist design makes this a unique product.

Линия лотков для столовых приборов WOOD SLIMLINE производится из МДФ окрашенного белым лаком.

Тонкие перегородки и минималистический дизайн делает этот продукт уникальным в своем роде.

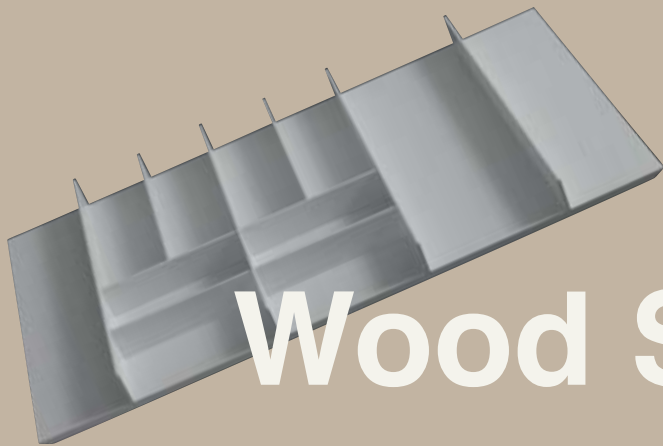

## Wood SlimLine

JUST BLUM TANDEMBOX

### Caratteristiche:

1. Realizzato in MDF verniciato bianco
2. Disponibile per cassetti da 400 a 1200 mm.
3. Disponibile accessorio portacoltelli
4. Verniciato con vernici eco sostenibili e certificata per alimenti
5. Facile da pulire.

### Features:

1. Made of MDF white painted.
2. Available for drawers from 400 to 1200 mm.
3. Available accessory a knife block holder.
4. Painted with environmentally sustainable and certified for food.
5. Easy to clean.

### Характеристики:

1. Лотки изготовлены из МДФ окрашенного белым лаком
2. Имеются модели для ящиков от 400 до 1200 мм.
3. Возможность дополнения
4. Экологичные и сертифицированные для контакта с пищевыми продуктами лаки.
5. Легкость очистки.





# Wood SlimLine



Porta coltelli  
*Knife block*  
Отсек для хранения ножей



Design minimale  
*Minimalist design*  
минималистический дизайн



MDF verniciato bianco  
White painted MDF  
МДФ окрашенного белым лаком

1 38X7X48,5

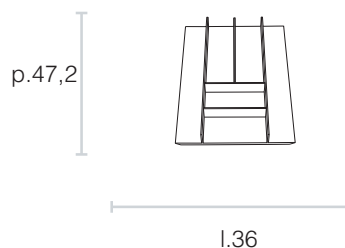

Cod. 08708620

PLC M50045 BLT18

MDF verniciato bianco  
White painted MDF  
МДФ окрашенного белым лаком

1 53X7X48,5

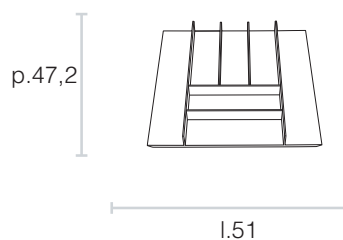

Cod. 08708621

PLC M50060 BLT18

MDF verniciato bianco  
White painted MDF  
МДФ окрашенного белым лаком

1 83X7X48,5

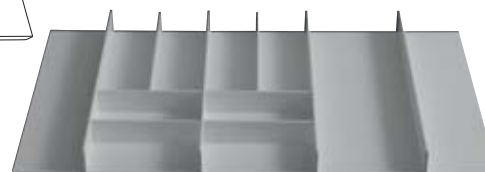
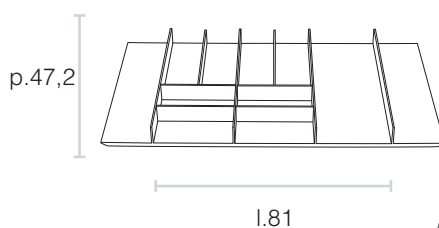

Cod. 08708622

Predisposto per due accessori - Can contain two accessories - Возможность установки двух принадлежностей

PLC M50090 BLT18

MDF verniciato bianco  
White painted MDF  
МДФ окрашенного белым лаком

1 112X7X48,5

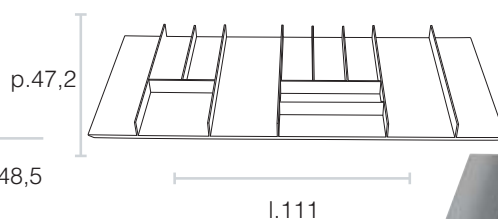

Cod. 08708623

Predisposto per quattro accessori - Can contain four accessories - Возможность установки четырех принадлежностей

PLC M50120 BLT18

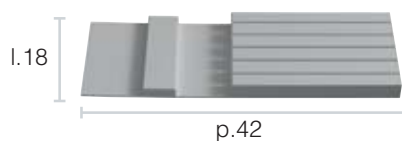

Porta coltelli  
Knife block  
Отсек для хранения ножей  
Cod. 08708625

PLC MCP

# elleipni

Portaposate in acciaio inox satinato (AISI 430) dal design elegante e curato.

Il fondo in acciaio satinato agevola la pulizia, i divisori in plastica sono rimovibili e permettono di personalizzare gli spazi.

Flexo si adatta ad ogni cassetto grazie alle sponde laterali mobili. Nato dalla collaborazione con i designers "Lineaguida"

Cutlery holder made of stainless steel (AISI 430) with an elegant and elaborated design.

The satin stainless steel base makes it easy to clean. The plastic dividers are removable and allow you to customise the space.

Flexo fits in all drawers thanks to its movable sides.

Developed in collaboration with the "Lineaguida" designers

Лоток для столовых приборов из матовой нержавеющей стали (AISI 430) с элегантным и продуманным дизайном.

Дно из матовой стали легко чистится, пластмассовые передвижные разделители позволяют организовать пространство согласно индивидуальным запросам.

Flexo подойдет к любому ящику благодаря подвижным боковым бортикам. Разработан совместно с дизайнерами "Lineaguida"

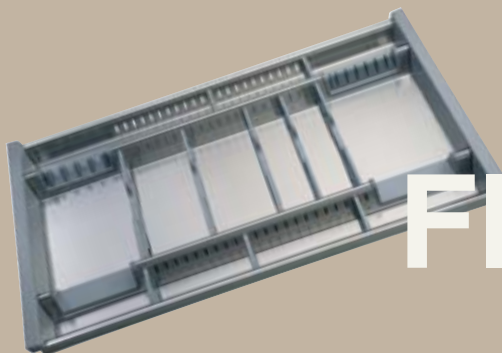

## Flexo

### Caratteristiche:

1. Prodotto in acciaio inox e plastica completamente riciclabile.
2. Disponibile per cassetti da 400 mm. a 1200 mm.
3. Fissaggio senza bisogno di forature
4. I divisori in plastica si possono spostare adattandosi alle diverse esigenze di spazio.
5. Facile da pulire.

### Features:

1. Stainless steel and recyclable plastic product.
2. Availability of 400 mm. to 1200 mm drawers.
3. Can be assembled without the need of fixing materials.
4. The plastic dividers can be moved to adapt to different space requirements.
5. Easy to clean.

### Характеристики:

1. Продукт из нержавеющей стали и пластмассы, полностью подлежащих вторичной переработке.
2. Имеются лотки для ящиков размером от 400 мм до 1200 мм.
3. Крепление не требует сверления отверстий
4. Разделители пластиковые могут быть перемещены путем адаптации к различным требованиям пространству.
5. Легкость очистки.



# Flexo



Sistema a molle laterali permette il fissaggio all'interno del cassetto.  
*Lateral springs system which allows adaptation inside drawers.*

Система на боковых пружинах, позволяющая адаптировать лоток к ящику.



I divisori in plastica si possono spostare adattandosi alle diverse esigenze di spazio.

*The plastic dividers can be moved to adapt to different space requirements.*

Разделители пластиковые могут быть перемещены путем адаптации к различным требованиям пространству.



Spazi progettati per porta coltelli e porta mestoli.

*Spaces designed for a knives holder and a ladles holder.*

Имеются отсеки для хранения ножей и половников.

R245/S

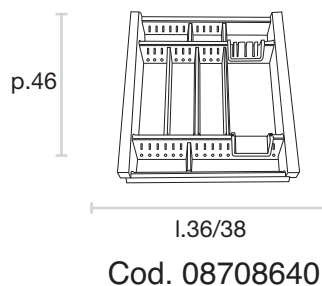

R260/S

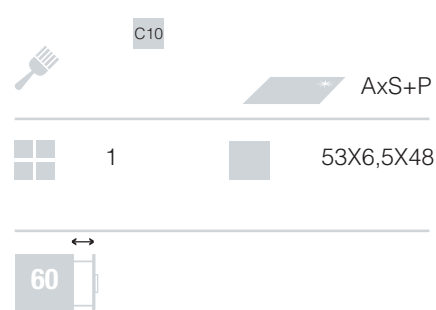
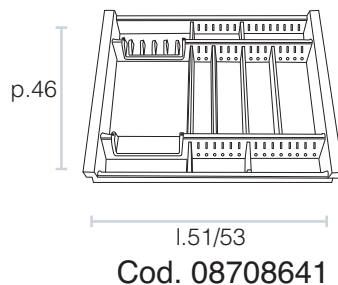

R290/S

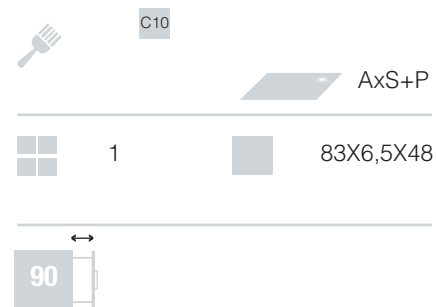
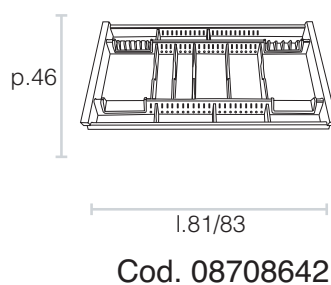

R320/S

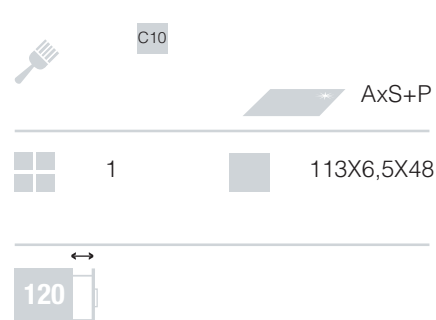
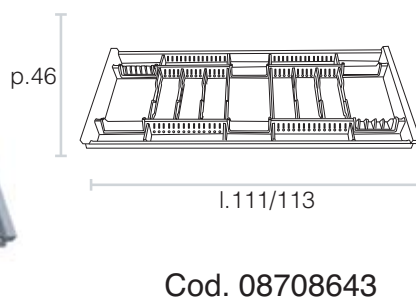



# Legenda - Key - легенда



Colore - Color - цвета



Estrazione totale - Total extraction - Полное выдвижение



Manico - Handle - Ручка

P Plastica - Plastic - Пластик

M Metallo - Metal - Металл



Filtro rigenerabile anti-odore

Anti-odour filter that can be regenerated

Очищаемый фильтр анти запахом



Guida - Runner - Направляющая

M Metallo - Metal - Металл

MR Metallo ritorno - Metal runner with return - Металл назад



Mobile con anta + dimensione minima

Kitchen cupboard with door + minimum size

Шкаф с дверцей + минимальный размер



Finitura - Finish - Отделка

P Plastica - Plastic - Пластик

AL Alluminio - Aluminum - Алюминий

AV Lamiera Verniciata - Varnished sheet metal - Окрашенная листовая сталь

ACR Acciaio Cromo - Chromium steel - Хромированная сталь

AXS Acciaio Inox Satinato - Satiny stainless steel

Сатинированная нержавеющая сталь



Mobile con cassetto + dimensione minima

Kitchen cabinet with drawer + minimum size

Шкаф с ящиком + минимальный размер



N° pezzi per imballo - N° of pieces per package

N° штук в упаковке



Apertura automatica del coperchio

Automatic lid opening

Автоматическое открытие крышки



Dimensione imballo - Package size - Размер упаковки

10

12

Capacità dei secchi in litri

Capacity of buckets in liters

Вместимость ведер в литрах

6

8

10

12

15

16

17

18

24

## Colore - Colors - цвета

C10

I colori del catalogo sono indicativi.

La Elletipi si riserva il diritto di effettuare modifiche ai propri prodotti senza obbligo di preavviso.

Catalogue's color are indicative.

Elletipi reserves the right to make modifications to its products without being obliged to give notice.

Цвета в каталоге, являются приблизительными.

Elletipi оставляет за собой право вносить изменения в свою продукцию без предварительного уведомления.



# PATTUMIERE

## WASTE BINS

	<p>Pattumiera in plastica</p> <p>Plastic waste bin</p>	<p><b>CODICE / CODE No.</b></p>	
	<p>Pattumiera inox estraibile 1 cesto</p> <p>Single basket stainless steel pull-out waste bin</p>	<p><b>08710600</b></p>	
	<p>Pattumiera inox estraibile 1 cesto</p> <p>Single basket stainless steel pull-out waste bin</p> <p>per basi sottolavello H63</p> <p>for sink base units H 63</p>	<p><b>08710625</b></p>	
	<p>Portadetersivi 30 cromato con serratura</p> <p>detergent holder, 30, chromed, with lock</p>	<p><b>08710627</b></p>	
		<p><b>08710500</b></p>	

# elleipni

Pattumiera girevole per mobili con anta ad estrazione automatica nelle versioni a 1 o 2 secchi.

Swivelling dustbin for cabinets with 1 or 2 buckets versions.

Поворотная емкость для мусора для шкафа со створкой с автоматическим выдвиганием в вариантах с 1 или с 2 ведрами.

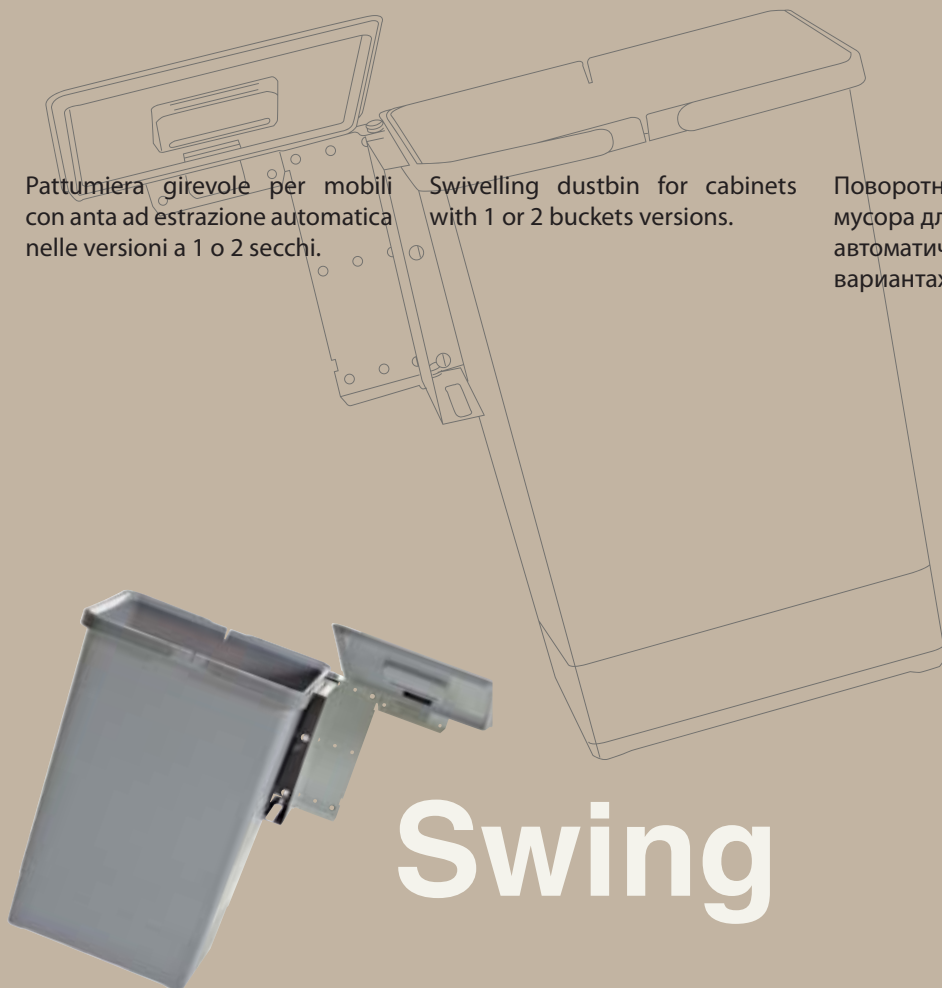

## Caratteristiche:

1. Robusto supporto girevole del secchio in acciaio verniciato a polvere.
2. Estrazione automatica collegata all'apertura dell'anta del mobile.
3. Possibilità di montare tutti secchi della serie CoverBox con capacità da 6 a 24 litri
4. Disponibile anche la versione con apertura automatica del coperchio.
5. Possibilità di montare due strutture sovrapposte.
6. Disponibile la versione a 2 secchi.
7. Facile da pulire.

## Features:

1. Robust swivel bucket made of powder painted steel.
2. Automatic extraction connected to the opening of the cabinet's shutter.
3. Possibility of mounting all of the Coverbox series buckets with capacities from 6 to 24 litres
4. Automatic lid opening version also available.
5. Possibility of mounting two overlapping structures.
6. Two buckets version available.
7. Easy to clean.

## Характеристики:

1. Прочная поворотная опора ведра из стали с порошковой лакировкой.
2. Автоматическое выдвигание при открытии створки шкафа.
3. Возможность установки любого ведра серии CoverBox емкостью от 6 до 24 литров.
4. Имеется также вариант с автоматическим открытием крышки.
5. Возможность монтажа двух ведер одного над другим.
6. Имеется вариант с 2 ведрами.
7. Легкость очистки.



Apertura automatica coperchio  
*Automatic lid opening*  
Автоматическое открытие  
крышки

Struttura girevole in metallo verniciato a polvere  
*Swivelling powder painted metal structure*  
Поворотная конструкция из металла с  
порошковой лакировкой

Coperchio con filtro rigenerabile anti-odore  
*Lid with an anti-odour filter which can be regenerated*  
Крышка с регенерируемым фильтром,  
поглощающим неприятные запахи

Supporto predisposto per il fissaggio  
*Support ready for fitting*  
Опора для крепления

Apertura automatica pattumiera  
*Automatic opening of the dustbin*  
Автоматическое открытие  
емкости для мусора

Struttura per secchi della serie CoverBox con  
capacità da 6 a 24 litri  
*Structure for the Coverbox series of buckets with  
capacities from 6 to 24 litres*  
Конструкция для ведер серии CoverBox  
емкостью от 6 до 24 литров

# Swing



PBD AA SG22 + PBD AM SG22

Possibilità di montare due secchi sovrapposti  
 Possibility of mounting two overlapping buckets  
 Возможность монтажа двух ведер одного над другим

NON INSERIBILE SU SOTTOLAVELLO LATO VASCA  
 CANNOT BE INSERTED UNDER THE SINK ON THE SIDE BASIN  
 НЕ УСТАНОВЛЕН ON HAND БАНЯ SINK

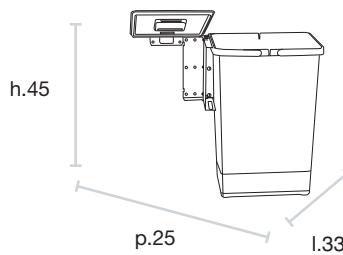
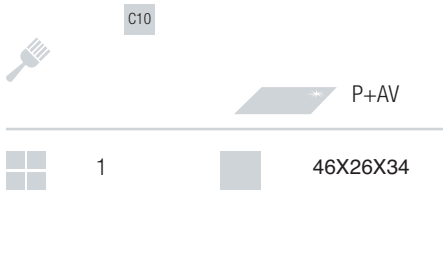

PBD AA SG44



24

Cod. 08710456

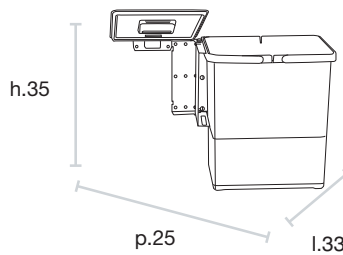
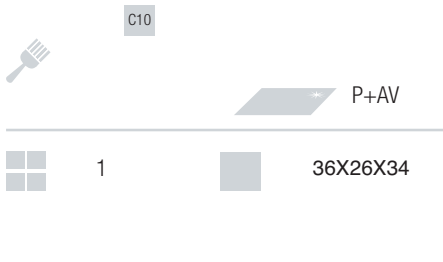

PBD AA SG34



18

Cod. 08710455

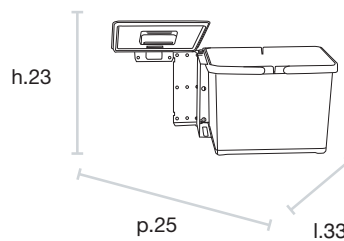
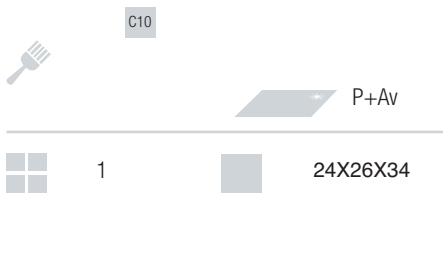

Cod. 08710454

PBD AA SG22 - PBD AM SG22



12

Disponibile anche in versione manuale PBD AM SG22  
 Also available in the PBD AM SG22 manual version  
 Имеется также ручной вариант PBD AM SG22

Cod. 08710453

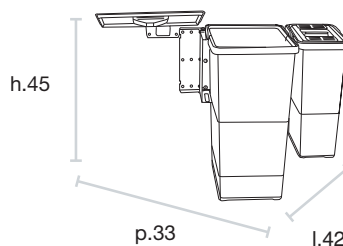
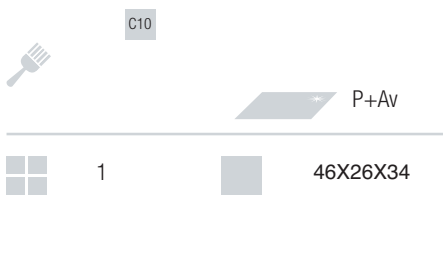

PBD BA SG44



24

6

Cod. 08710457

# ellettipi

Linea di pattumiere da base realizzate in filo di acciaio cromato per raccolta differenziata. Offre un'ampia gamma di soluzioni utilizzando i secchi della serie CoverBox.

A dustbin product line made of chromed steel wire for the separate collection of waste. It offers a wide range of solutions using the Coverbox series buckets.

Линия емкостей для отдельного сбора мусора из стального хромированного прутка. Предлагается широкая гамма решений с использованием ведер серии CoverBox.



# Ecofil

### Caratteristiche:

1. Struttura in filo di acciaio cromato riciclabile.
2. Guide ad estrazione totale in acciaio
3. Fornito in differenti larghezze e profondità.
4. Varie combinazioni di secchi della serie CoverBox.
5. Facile da pulire.
6. Semplicità di installazione con l'utilizzo di sole 4 viti.

### Features:

1. Frame made of recycled chromed steel wire.
2. Full extraction runners made of steel.
3. Supplied in different width-and depths.
4. Various combinations of Coverbox series buckets.
5. Easy to clean.
6. Easy to assemble with just 4 screws.

### Характеристики:

1. Конструкция из стального хромированного прутка, подлежащего вторичной переработке.
2. Стальные направляющие с полным выдвижением.
3. Возможны различные варианты ширины и глубины.
4. Различные комбинации ведер серии CoverBox.
5. Легкость очистки.
6. Простота установки при помощи всего 4 винтов.







# Ecofil



 C10  M  
 Acr  
 1  25X43X47  
 30 

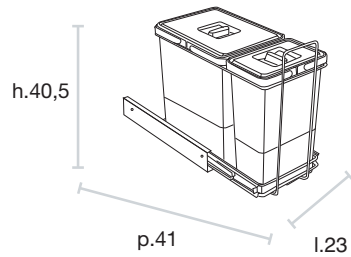

Cod. 08710448

PF01 34A1

 C10  M  
 Acr  
 1  32X43X47  
 40 

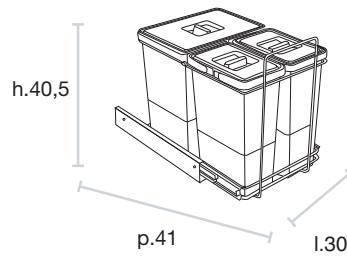

Cod. 08710450

PF01 34B1

 C10  M  
 Acr  
 1  25X43X47  
 30 

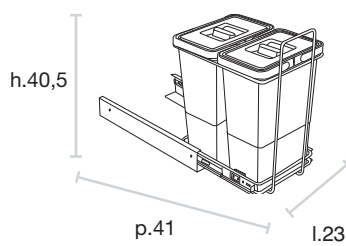

Cod. 08710449

PF01 34C2

 C10  M  
 Acr  
 1  32X43X53  
 40 

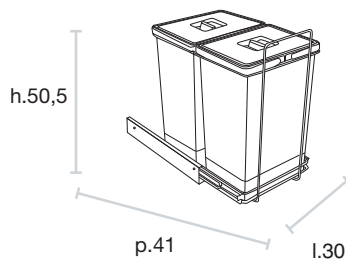

Cod. 08710451

PF01 44B2

# elle tipi

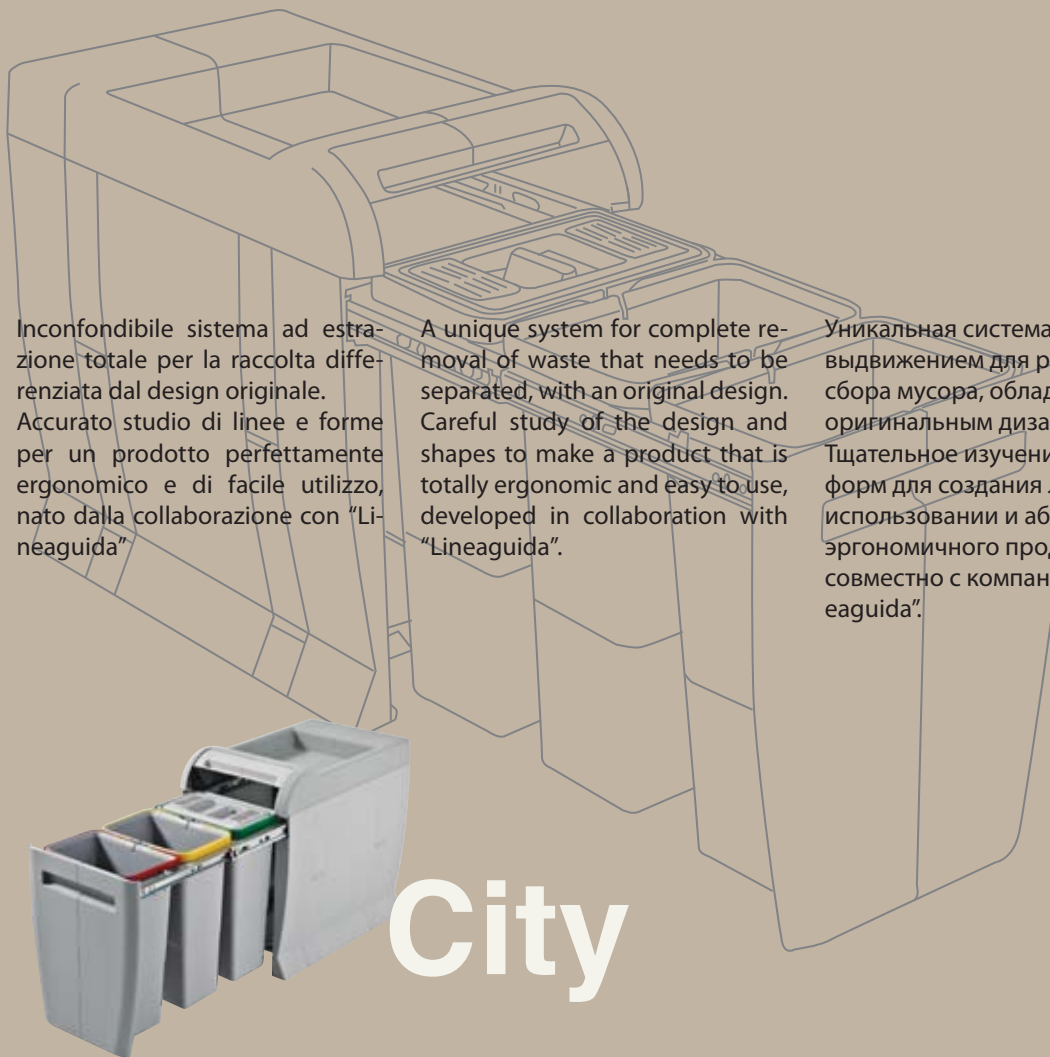

Inconfondibile sistema ad estrazione totale per la raccolta differenziata dal design originale. Accurato studio di linee e forme per un prodotto perfettamente ergonomico e di facile utilizzo, nato dalla collaborazione con "Lineaguida".

A unique system for complete removal of waste that needs to be separated, with an original design. Careful study of the design and shapes to make a product that is totally ergonomic and easy to use, developed in collaboration with "Lineaguida".

Уникальная система с полным выдвижением для раздельного сбора мусора, обладающая оригинальным дизайном. Тщательное изучение линий и форм для создания легкого в использовании и абсолютно эргономичного продукта совместно с компанией "Lineaguida".

## City

### Caratteristiche:

1. Prodotto in plastica completamente riciclabile.
2. Guide ad estrazione totale in metallo.
3. Fornito in 3 larghezze e 2 profondità.
4. Sportello a ribalta, unico nel suo genere, per gettare i rifiuti di piccole dimensioni.
5. Ripiano superiore utilizzabile come portaoggetti (detersivi, spugne...).
6. Tutte le pattumiere sono dotate di un secchio con coperchio con filtro antiodore (rigenerabile con lavaggio fino a 50 volte).
7. Fianco sagomato salva spazio.
8. Semplicità di installazione con solo 4 viti.

### Features:

1. Fully recyclable plastic product.
2. Runners and extraction device made only of metal.
3. Supplied in 3 widths and 2 depths.
4. A unique hatch with a flap to dispose of small pieces of waste.
5. Upper shelf that can be used to keep objects (detergents, sponges, etc.).
6. All the bins have a bucket and a lid with an odour filter (which can be regenerated by washing for up to 50 times).
7. Space saving shaped side.
8. Easy to assemble with just 4 screws.

### Характеристики:

1. Продукт из пластмассы, полностью подлежащей вторичной переработке.
2. Металлические направляющие с полным выдвижением.
3. Возможны 3 варианта ширины и 2 варианта глубины.
4. Единственная в своем роде откидная крышка для выброса мелких отходов.
5. Верхняя полка может быть использована в качестве подставки для моющих средств, губок и т.п.
6. Все емкости для мусора укомплектованы ведром с крышкой с фильтром, поглощающим неприятные запахи (регенерируемый фильтр выдерживает до 50 моек).
7. Фигурная боковая стенка для экономии места.
8. Простота установки при помощи всего 4 винтов.



Vaschetta superiore porta oggetti

*Upper shelf for holding objects*

Верхний лоток для мелочей

Sportello a ribalta per piccoli rifiuti

*A hatch which flips open for the disposal of small waste*

Откидная крышка для мелких отходов

Coperchio con filtro rigenerabile anti-odore

*Lid with an anti-odour filter that can be regenerated*

Крышка с регенерируемым фильтром, поглощающим неприятные запахи

Fianco sagomato salva spazio

*Space saving shaped side*

Фигурная боковая стенка для экономии места

Supporto predisposto per il fissaggio

*Support ready for fitting*

Опора для крепления

Guida in acciaio ad estrazione totale

*Steel slide for full extraction*

Стальная направляющая с полным выдвиганием

# City



Fianco sagomato salva spazio.  
*Space saving shaped sides.*  
 Фигурная боковая стенка для экономии места



Sportello a ribalta per rifiuti di piccole dimensioni.  
*A hatch which flips open for the disposal of small waste.*  
 Откидная крышка для мелких отходов



Vaschetta superiore utilizzabile come portaoggetti.  
*Upper tray for holding objects.*  
 Верхний лоток для мелочей

C10 M P  
 1 43X28X44

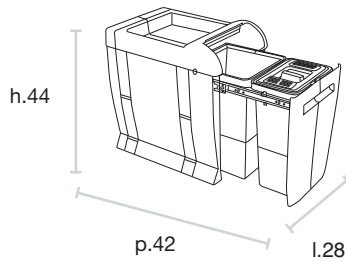

PTA 3040A

Cod. 08710440

C10 M P  
 1 43X36X44

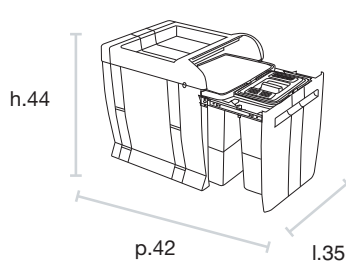

PTA 4040A

Cod. 08710443

C10 M P  
 1 43X36X44

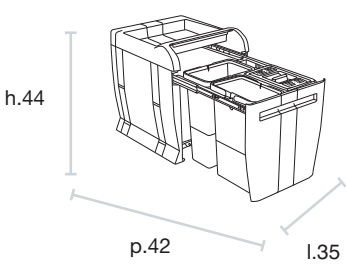

PTA 4040B

Cod. 08710441

C10 M P  
 1 43X52X44

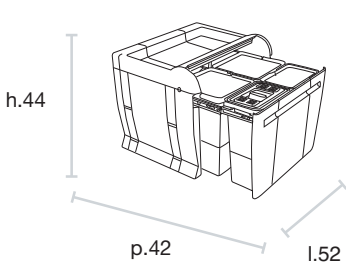

PTA 5040A

Cod. 08710442

# elle tipi

Unico nel suo genere il Sistema di pattumiere Metropolis è un accessorio da inserire direttamente nei cassettoni.

Un sistema flessibile che si adatta alle svariate misure interne dei cassetti, completamente modulare e dal montaggio estremamente semplice.

The unique Metropolis dustbins system is an accessory that fits directly into drawers.

A flexible system that adapts to various internal sizes of drawers, completely modular and extremely easy to assemble.

Metropolis, единственная в своем роде система контейнеров для мусора, вставляемых непосредственно в ящики. Гибкая, необычайно простая в монтаже и полностью модульная система, подходящая для ящиков с различными внутренними размерами.

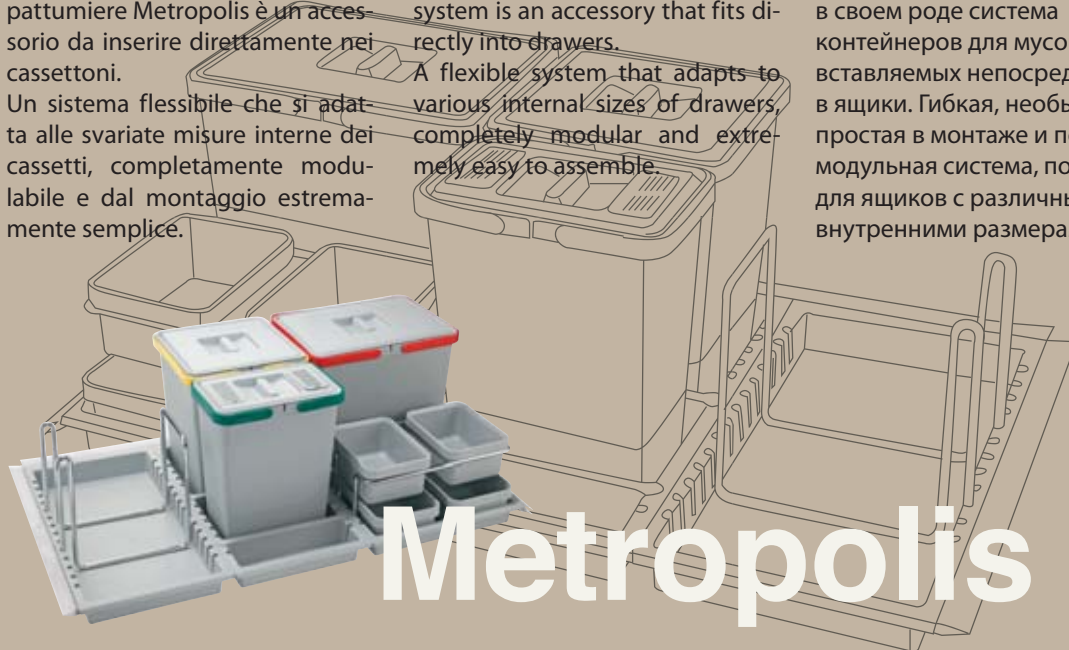

## Caratteristiche:

1. Disponibile in 2 altezze e 3 larghezze.
2. Fornito con guarnizione flessibile per compensare le eventuali differenze di misura bloccando perfettamente il vassoio.
3. Il modello in plastica è dotato di più vasche componibili, fornite in kit di montaggio, con una notevole riduzione di ingombro dell'imballo.
4. La possibilità di spostare i divisori garantisce estrema flessibilità.
5. È possibile l'aggiunta di accessori in filo d'acciaio cromato. (porta detersivo, porta vaschette, porta carta)
6. Tutte le pattumiere sono dotate di un secchio con coperchio con filtro antiodore (rigenerabile con lavaggio fino a 50 volte).

## Features:

1. Available in 2 widths and 3 heights.
2. Supplied with a flexible seal to compensate for any differences in terms of size, fully blocking the tray.
3. The plastic model has a number of modular trays, supplied in kit form, with a significant reduction in the overall size of the packaging.
4. The dividers can be re-positioned to ensure flexibility.
5. Accessories in chromed steel wire can be added. (detergents holder, trays holder, paper holder).
6. All the bins have with a bucket with a lid which has an odour filter (which can be regenerated by washing for up to 50 times).

## Характеристики:

1. Возможны 2 варианта высоты и 3 варианта ширины.
2. Поставляется с гибким уплотнением для компенсации возможных различий в размерах, обеспечивающим надежную фиксацию нижнего лотка.
3. Пластмассовая модель укомплектована несколькими модульными емкостями, поставляемыми в разобранном виде, что значительно уменьшает размеры упаковки.
4. Возможность перемещения разделителей гарантирует необыкновенную универсальность системы.
5. Возможность дополнения принадлежностями из стального хромированного прутка. (держатель для моющего средства, лотков, бумаги).
6. Каждая емкость для мусора укомплектована ведром с крышкой с фильтром, поглощающим неприятные запахи (регенерируемый фильтр выдерживает до 50 моек).

## COPERTURA AUTOMATICA - AUTOMATIC COVERAGE - АВТОМАТИЧЕСКОЕ ПОКРЫТИЕ

**PВНСВ06050** Cod. 08710477 Modulo 600 mm. - Module 600 mm. - Модуль 600 мм

**PВНСВ09050** Cod. 08710478 Modulo 900 mm. - Module 900 mm. - Модуль 900 мм

**PВНСВ12050** Cod. 08710479 Modulo 1200 mm. - Module 1200 mm. - Модуль 1200 мм





Coperchio con filtro assorbi odori  
*Lid with odour absorbing filter*  
Крышка с фильтром, поглощающим неприятные запахи

Guarnizione flessibile blocca vassoio su tre lati  
*Flexible seal to block trays on three sides*  
Гибкий уплотнитель, фиксирующий емкость по трем сторонам

Disponibili accessori porta riviste, porta detersivi e porta vaschette  
*Availability of accessories such as magazines holders, detergents holder and trays holder*  
Возможна установка следующих принадлежностей: держатели для журналов, моющих средств, лотков.

Divisorio posizionabile per un'estrema flessibilità nell'organizzazione degli spazi.  
*Divider which can be positioned for extreme space flexibility*  
Подвижный разделитель, обеспечивающий необычайную гибкость при организации пространства.

Vasche collegabili fornite in kit  
*The kit includes attachable trays*  
Соединяемые лотки, поставляемые в наборе

C10

**Per modelli con gola**  
For models with finger rail

P

1 47X25X33

60

12 12

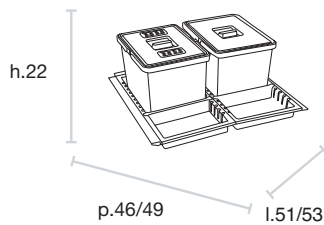

Cod. 08710463



PTC22 06050 1F

C10

P

1 47X31X35

90

12 12 12

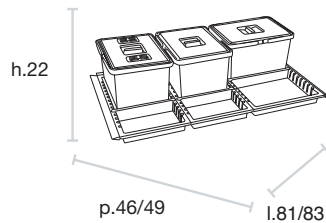

Cod. 08710464



PTC22 09050 1F

C10

P

1 47X31X43

120

12 12 12 12

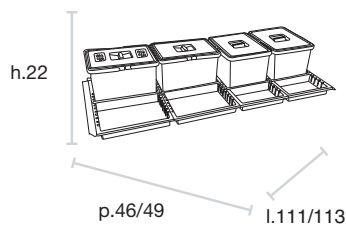

Cod. 08710465



PTC22 12050 1F

C10

**Per modelli senza gola**  
For models without finger rail

P

1 47X25X33

60

6 10 10 15

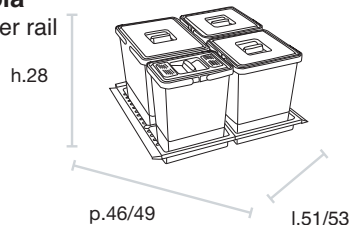

Cod. 08710466



PTC28 06050 2F

C10

P

1 47X31X35

90

6 10 10 15

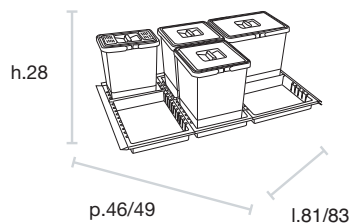

Cod. 08710467



PTC28 09050 2F

C10

P

1 47X31X43

120

15 15 15 15

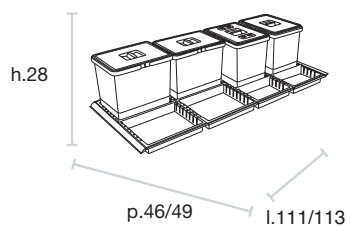

Cod. 08710468



PTC28 12050 4F

# LUCI LIGHTS

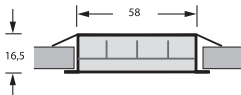

Farretti incasso a led  
Led recessed spotlights

**CODICE / CODE No.**

Cromo/ Chrome  
Nichel satinato/ Satin nickel  
Ottone antico/ Antique brass

**08610010**  
**08610011**  
**08610012**

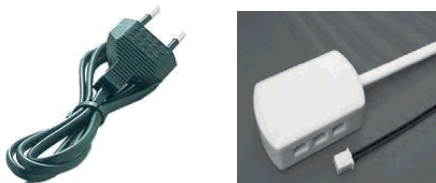

Alimentatore per Power LED 350 mA 6W  
Power supply for Power LED 350 mA 6W

Alimentatore per Power LED 350 mA 6W cablato con distributore  
fino a 6 connessioni con cavo bipolare L 35 cm

Power supply for Power LED 350 mA 6W wired distributor with up to 6  
connections with bipolar cable W 35 cm

max 6 faretti / max 6 spotlight

**08610015**

# FARETTO INCASSO A LED LED RECESSED SPOTLIGHT

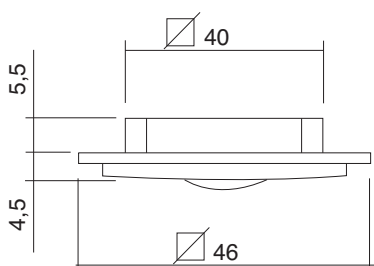

Faretto quadrato 1 Led 1,2 w finitura acciaio inossidabile  
one led spotlight square stainless steel finish

**CODICE**  
**CODE No.**

Faretto cad.  
Alimentatore max 4 faretti

spotlight each  
power max 4 spotlight

**08610005**  
**08610006**

# LUCI LIGHTS

	<p>Fondo luminoso led per pensile finitura brill (opz.055)</p> <p><b>N.B.: da richiedere montato al mobile</b></p> <p>Illuminous for wall unit brill finish (opz.055)</p> <p>Note: mounted on wall unit on request</p>	<p><b>CODICE / CODE No.</b></p>	
	<p>Presu su fondo in alluminio con luce led integrata con interruttore (opz.070) per pensili</p> <p><b>N.B.: da richiedere montato al mobile</b></p> <p>Gripion bottom with integrated led light brill finish with touch control (opz.070) for wall unit</p> <p>Note: mounted on wall unit on request</p>		
	<p>Mensola luminosa alluminio con diffusore superiore ed inferiore in vetro temprato con interruttore e presa</p> <p>Aluminium luminous shelf with tempered glass upper and lower diffuser with switch and socket</p>	<p>Finitura brill L 60 Finitura brill L 90 Finitura brill L 120</p> <p>Brill finish L 60 Brill finish L 90 Brill finish L 120</p>	<p><b>08610297</b> <b>08610298</b> <b>08610299</b></p>

## SISTEMI DI ILLUMINAZIONE LUNA LUNA LIGHTING SYSTEMS



**FORMA € FUNZIONE®**

Un sistema di illuminazione dotato di **LED di potenza da 3W.**

A lighting system with 3W leds

### Disponibile in 3 versioni

Available in 3 versions



**LUNA interno base**  
LUNA base interior



**LUNA interno pensile**  
LUNA wall unit interior



**LUNA cestone**  
LUNA deep drawer

### 2 TIPI DI ACCENSIONE

2 control types



**Sensore di presenza / Presence sensor**  
Per Luna interno pensile o base  
For Luna wall unit/base interior



**Interruttore elettronico a sfioro con LED di segnalazione.**  
Electronic touch sensitive switch with signal led.  
Per Luna sottopensile  
For Luna under wall unit

### MONTAGGIO / ASSEMBLY

1. Allineare la clip tramite la dima integrata. Avvitare in posizione la clip
2. Rimuovere la dima integrata
3. Basterà una semplice pressione per montare LUNA alla clip

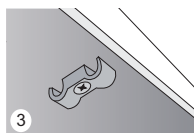
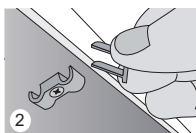
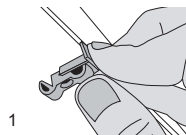

1. Align the clip with its integrated template. Screw the clip into place
2. Remove the integrated template
3. Simply press to mount LUNA onto the clip

### CARATTERISTICHE COSTRUTTIVE STRUCTURAL CHARACTERISTICS

- **Spessore** di 12mm / Thickness 12mm
- **Schermo** in policarbonato satinato trasparente / Screen in transparent satin-finish polycarbonate
- **Profilo** di alluminio anodizzato naturale / Natural anodised aluminium profile

### I VANTAGGI

- Adattabilità per tutti i mobili
- Elevata efficacia luminosa
- Varietà di soluzioni per l'accensione
- Unica soluzione per l'intero ambiente cucina
- Design elegante, discreto e funzionale
- Modularità
- Facile montaggio

### BENEFITS

- Adapt to all units
- Excellent lighting effect
- Variety of control solutions
- Single solution for the entire kitchen
- Elegant, discrete, functional design
- Modular construction
- Easy to install

# LUNA INTERNO PENSILE

## LUNA WALL UNIT INTERIOR

**Profilo in alluminio anodizzato naturale dotato di LED di potenza da 3W e schermo in policarbonato satinato trasparente con sensore.**

Natural anodised aluminium profile with 3W leds and transparent satin-finished polycarbonate screen with sensor.

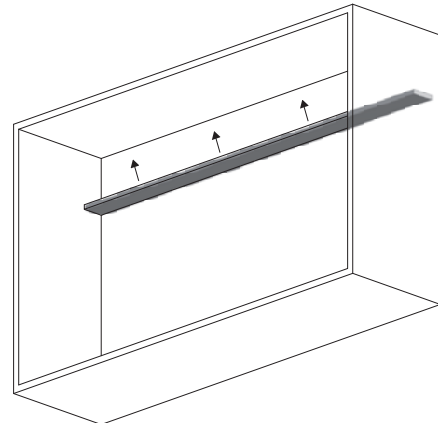
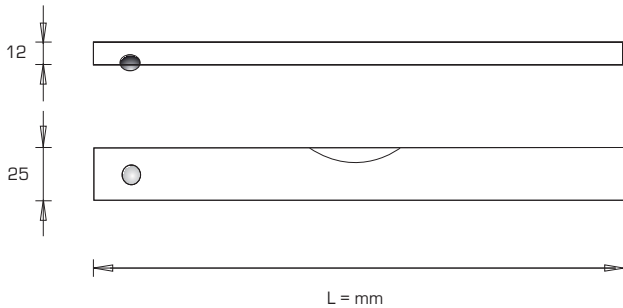

	<p><b>Barra Luna interno pensile</b> 1 Led 3W</p> <p>Luna wall unit interior bar, 1 3W Led</p> <p>L 141 per pensile 45 anta dx-sx L 146 per pensile 60 ribalta L 156 per pensile 60 anta dx-sx L 176 per pensile 90 ribalta L 186 per pensile 90 2 ante</p>	<p>W 141 for 45 wall unit, RH/LH door W 146 for 60 wall unit with flap door W 156 for 60 wall unit, RH/LH door W 176 for 90 wall unit with flap door W 186 for 90 wall unit with 2 doors</p>	<p><b>CODICE</b> <i>CODE No.</i></p> <p><b>08609523</b> <b>08609524</b> <b>08609525</b> <b>08609526</b> <b>08609527</b></p>	
	<p><b>Alimentatore max 30W (24V)</b> <b>per la connessione contemporanea di massimo 7 Led da 3W</b></p>	<p>Power supply max. 30W (24V) for connecting up to 7 3W leds</p>	<p><b>08609553</b></p>	

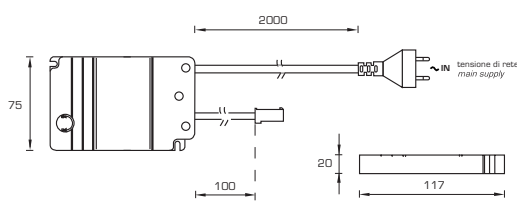

# LUNA INTERNO BASE

## LUNA BASE INTERIOR

**Profilo in alluminio anodizzato naturale dotato di LED di potenza da 3W e schermo in policarbonato satinato trasparente. Accensione con sensore**

Natural anodised aluminium profile with 3W leds and transparent satin-finished polycarbonate screen.  
Sensor controlled

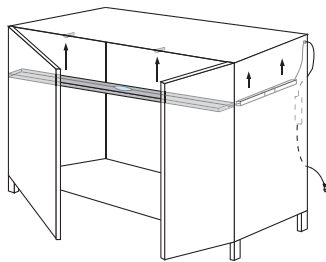
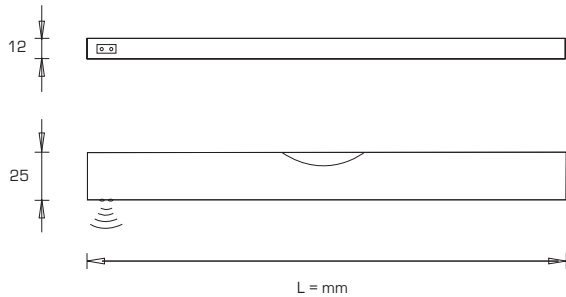

**Barra Luna per basi con anta**  
**Accensione con sensore**

Luna bar for base with door  
Sensor controlled

***CODICE***  
***CODE No.***

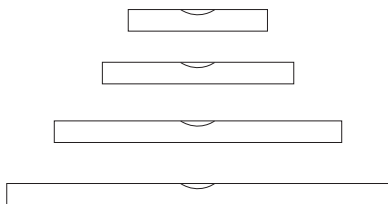

L 041  
L 056  
L 086  
L 116

W 041  
W 056  
W 086  
W 116

**08609533**  
**08609535**  
**08609537**  
**08609539**

**Alimentatore max 30W (24V)**  
**per la connessione**  
**contemporanea di massimo 7**  
**Led da 3W**

Power supply max. 30W (24V) for  
connecting up to 7 3W leds

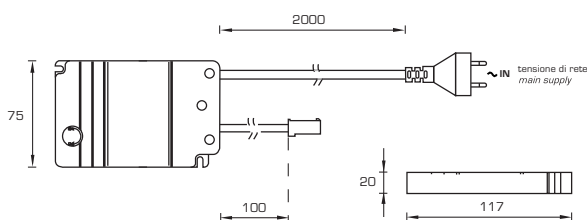

**08609553**



# LUNA CESTONE

## LUNA DEEP DRAWER

**Profilo in alluminio anodizzato naturale dotato di LED di potenza da 3W e schermo in policarbonato satinato trasparente.**  
**Il LED illumina verso l'esterno. Accensione con sensore**

Natural anodised aluminium profile with 3W leds and transparent satin-finished polycarbonate screen.

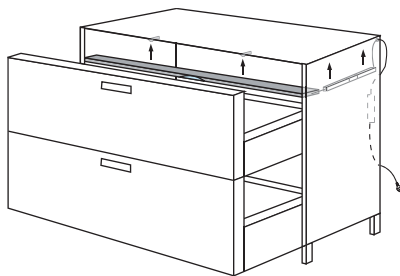
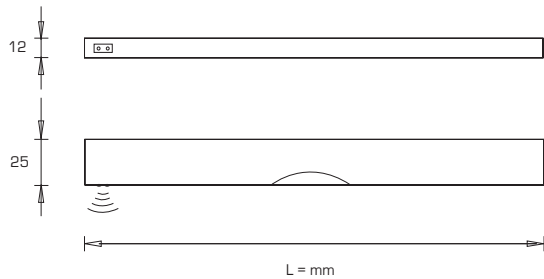

**Barra Luna per basi con anta**  
**Accensione con sensore**

Luna bar for deep drawers  
 Sensor controlled

**CODICE**  
**CODE No.**

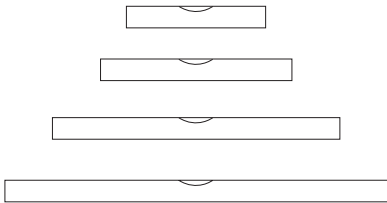

L 056  
 L 086

W 056  
 W 086

**08609545**  
**08609547**

**Alimentatore max 30W (24V)**  
**per la connessione**  
**contemporanea di massimo 7**  
**Led da 3W**



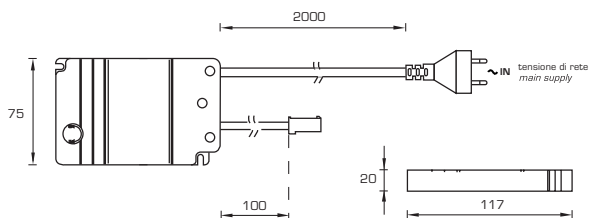

Power supply max. 30W (24V) for  
 connecting up to 7 3W leds



**08609553**

# ACCESSORI SOTTOPENSILI "RITMO"

## "RITMO" UNDER WALL UNIT ACCESSORIES



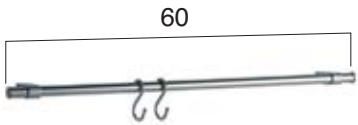
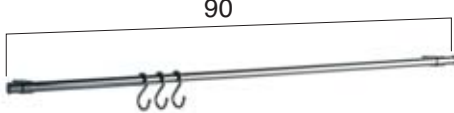
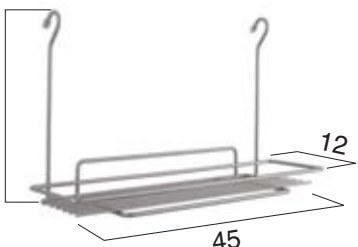
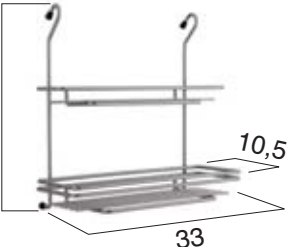
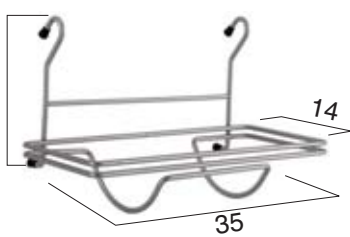
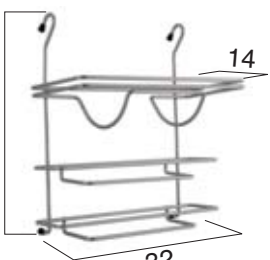

	<p><b>Confezione Barra porta mestoli con 4 ganci cromata</b></p>	<p>Ladle holder bar set with 4 hooks, chromed</p>	<p><b>CODICE / CODE No.</b></p>	
	<p>L 56 L 86 L 116</p>	<p>W 56 W 86 W 116</p>	<p><b>08607983</b> <b>08607985</b> <b>08607987</b></p>	
	<p><b>Porta-barattoli cromato</b></p>	<p>Can holder chromed</p>		
	<p><b>L 290 x P 155 x H 235</b></p>	<p>W 290 x D 155 x H 235</p>	<p><b>08607990</b></p>	
	<p><b>Porta-spezie cromato</b></p>	<p>Spice rack chromed</p>		
	<p><b>L 270 x P 100 x H 235</b></p>	<p>W 270 x D 100 x H 235</p>	<p><b>08607993</b></p>	
	<p><b>Porta-rotolo cromato</b></p>	<p>Tissue roll holder chromed</p>		
	<p><b>L 290 x P 130 x H 200</b></p>	<p>W 290 x D 130 x H 200</p>	<p><b>08607995</b></p>	
	<p><b>Confezione n. 4 ganci ad "S" cromati</b></p>	<p>Set of 4 S-shaped chromed hooks</p>		
			<p><b>08607980</b></p>	

# ACCESSORI SOTTOPENSILI

## UNDER WALL UNIT ACCESSORIES

 <p>60</p>	<p><b>Kit 60 completo di:</b>          1 barra da 60          2 terminali          2 supporti          2 ganci singoli</p> <p>Cromo          Satinato          Ottone antico          Argento antico</p>	<p>Kit 60 complete with:          1 60 cm rod          2 end caps          2 supports          2 single hooks</p> <p>Chrome          Satin          Antique brass          Antique silver</p>	<p><b>CODICE / CODE No.</b></p> <p><b>08600900</b>  <b>08600901</b>  <b>08600904</b>  <b>08600905</b></p>
 <p>90</p>	<p><b>Kit 90 completo di:</b>          1 barra da 90          2 terminali          2 supporti          3 ganci singoli</p> <p>Cromo          Satinato          Ottone antico          Argento antico</p>	<p>Kit 90 complete with:          1 90 cm rod          2 end caps          2 supports          3 single hooks</p> <p>Chrome          Satin          Antique brass          Antique silver</p>	<p><b>08600910</b>  <b>08600911</b>  <b>08600914</b>  <b>08600915</b></p>
 <p>24,5          12          45</p>	<p><b>Multiuso 1</b></p> <p>Cromo          Satinato          Ottone antico          Argento antico</p>	<p>Multifunctional set 1</p> <p>Chrome          Satin          Antique brass          Antique silver</p>	<p><b>08600950</b>  <b>08600951</b>  <b>08600954</b>  <b>08600955</b></p>
 <p>31,5          10,5          33</p>	<p><b>Multiuso 2</b></p> <p>Cromo          Satinato          Ottone antico          Argento antico</p>	<p>Multifunctional set 2</p> <p>Chrome          Satin          Antique brass          Antique silver</p>	<p><b>08600930</b>  <b>08600931</b>  <b>08600934</b>  <b>08600935</b></p>
 <p>21          14          35</p>	<p><b>Mensola con 1 portarotolo</b></p> <p>Cromo          Satinato          Ottone antico          Argento antico</p>	<p>Shelf with 1 tissue roll holder</p> <p>Chrome          Satin          Antique brass          Antique silver</p>	<p><b>08600920</b>  <b>08600921</b>  <b>08600924</b>  <b>08600925</b></p>
 <p>35          14          32</p>	<p><b>Tris portarotoli</b></p> <p>Cromo          Satinato          Ottone antico          Argento antico</p>	<p>3-tier tissue roll holder</p> <p>Chrome          Satin          Antique brass          Antique silver</p>	<p><b>08600940</b>  <b>08600941</b>  <b>08600944</b>  <b>08600945</b></p>

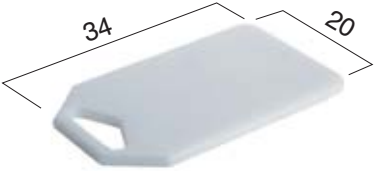
## ACCESSORI SOTTOPENSILI UNDER WALL UNIT ACCESSORIES

	<p><b>Mensola con 2 portarotoli</b> Shelf with 2 tissue roll holders</p> <p>Cromo Satinato Ottone antico Argento antico</p> <p>Chrome Satin Antique brass Antique silver</p>	<p><b>CODICE / CODE No.</b></p> <p><b>08600990</b> <b>08600991</b> <b>08600944</b> <b>08600945</b></p>	
	<p><b>Set portaspezie</b> Spice holder set</p>	<p><b>08600960</b></p>	
	<p><b>Tagliere in poliammide</b> Poly amide chopping board</p>	<p><b>08600970</b></p>	
	<p><b>Ganci per barra</b> Hooks for rod</p> <p>Gancio Cromo cad. Gancio Satinato cad. Gancio Ottone antico cad. Gancio Argento antico cad.</p> <p>Chrome hook (pc) Satin hook (pc) Antique brass hook (pc) Antique silver hook (pc)</p>	<p><b>08600880</b> <b>08600881</b> <b>08600884</b> <b>08600885</b></p>	

## ACCESSORI SOTTOPENSILI "TITAN"

### "TITAN" UNDER WALL UNIT ACCESSORIES







	<p><b>kit barra alluminio finitura acciaio spazzolato (completa di supporti, tappi e 3 ganci)</b></p> <p>kit for aluminium bar with brushed steel finish (including brackets, caps and 3 hooks)</p>	<p><b>CODICE / CODE No.</b></p>	
	<p><b>mensola alluminio finitura acciaio spazzolato con supporti (esclusa barra)</b></p> <p>aluminium shelf with brushed steel finish including brackets (bar excluded)</p>	<p><b>08607810</b> <b>08607813</b> <b>08607816</b></p>	
	<p><b>mensola vetro con supporti, per colori vedi ante vetro colorato (esclusa barra)</b></p> <p>glass shelf with brackets for colours see colored glass doors (bar excluded)</p>	<p><b>08607823</b> <b>08607825</b> <b>08707828</b></p>	
	<p><b>mensola portascottex alluminio finitura acciaio spazzolato (esclusa barra) aluminium tissue roll holder shelf with brushed steel finish (bar excluded)</b></p> <p>aluminium tissue roll holder shelf with brushed steel finish (bar excluded)</p>	<p><b>08607853</b> <b>08607855</b> <b>08607858</b></p>	

## ACCESSORI SOTTOPENSILI "ONDA" "ONDA" UNDER WALL UNIT ACCESSORIES

	<p>confezione barra onda con 3 ganci</p>	<p>onda bar set with 3 hooks</p>	<p><b>CODICE / CODE No.</b></p>	
	<p>barra L 60 H 3,5 P 8 barra L 90 H 3,5 P 8 barra L 120 H 3,5 P 8 porta rotolo L 29</p>	<p>rod W 60 H 3,5 D 8 rod W 90 H 3,5 D 8 rod W 120 H 3,5 D 8 tissue roll holder W 29</p>	<p><b>08608150</b> <b>08608151</b> <b>08608152</b> <b>08608159</b></p>	
	<p>confezione mensola onda reversibile con 3 ganci</p>	<p>onda shelf reversible set with 3 hooks</p>	<p><b>08608155</b> <b>08608156</b> <b>08608159</b></p>	
	<p>mensola L 90 H 3,5 P 17,5 mensola L 120 H 3,5 P 17,5 porta rotolo L 29</p>	<p>shelf W 90 H 3,5 D 17,5 shelf W 120 H 3,5 D 17,5 tissue roll holder W 29</p>		
	<p>confezione barra onda con 3 ganci</p>	<p>onda bar set with 3 hooks</p>	<p><b>08608160</b> <b>08608161</b> <b>08608162</b> <b>08608169</b></p>	
	<p>barra L 60 H 3,5 P 8 barra L 90 H 3,5 P 8 barra L 120 H 3,5 P 8 porta rotolo L 29</p>	<p>rod W 60 H 3,5 D 8 rod W 90 H 3,5 D 8 rod W 120 H 3,5 D 8 tissue roll holder W 29</p>		
	<p>confezione mensola onda reversibile con 3 ganci</p>	<p>onda shelf reversible set with 3 hooks</p>	<p><b>08608165</b> <b>08608166</b> <b>08608169</b></p>	
	<p>mensola L 90 H 3,5 P 17,5 mensola L 120 H 3,5 P 17,5 porta rotolo L 29</p>	<p>shelf W 90 H 3,5 D 17,5 shelf W 120 H 3,5 D 17,5 tissue roll holder W 29</p>		

# ACCESSORI SOTTOPENSILI "PRATIKA"

## "PRATIKA" UNDER WALL UNIT ACCESSORIES

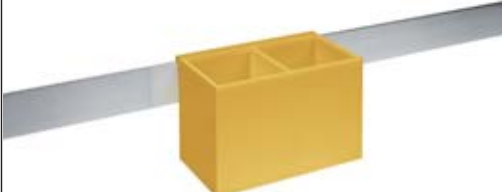
	<i>CODICE</i> <i>CODE No.</i>			<i>CODICE</i> <i>CODE No.</i>									
<b>kit barra completa di supporti e tappi</b> <b>(esempio con 3 ganci)</b> kit bar including brackets and caps (example with 3 hooks) 			<b>portatovaglioli</b> <b>(esclusa barra)</b> napkin (bar excluded) 										
	L 60 P 2,3 H 4 (2 ganci) (2 hooks) finitura brill brill finish	08608751											
	L 90 P 2,3 H 4 (3 ganci) (3 hooks) finitura brill brill finish	08608752			L 12 P 2,8 H 9 W 12 D 2,8 H 9	08608758							
<b>portabarattoli</b> <b>(esclusa barra)</b> jar-rack (bar excluded) 			<b>porta tablet</b> <b>(esclusa barra)</b> leads tablet (bar excluded) 										
	L 27 P 14 H 7,5 W 27 D 14 H 7,5	08608755			L 25 P 4 H 15 W 25 D 4 H 15	08608760							
<b>portaspezie</b> <b>(esclusa barra)</b> spice-rack (bar excluded) 			<b>portarotolo</b> <b>(esclusa barra)</b> tissue-roll (bar excluded) 										
	L 26 P 7,5 H 7,5 W 26 D 7,5 H 7,5	08608756			L 24,5 P 13 H 6 W 24,5 D 13 H 6	08608759							
<b>portaposate</b> <b>(esclusa barra)</b> cutlery (bar excluded) 			<b>colori opachi</b> matt colors: <table border="1" data-bbox="805 1568 1284 1814"> <tr> <td> <b>bianco assoluto</b>                              (opz.740)                              white absolute                         </td> <td> <b>vulcano</b>                              (opz.9615)                              volcano                         </td> <td> <b>bruno antilope</b>                              (opz.9541)                              brown antelope                         </td> <td> <b>acquamarina</b>                              (opz.8323)                              aquamarine                         </td> </tr> <tr> <td> <b>salvia</b>                              (opz.8443)                              sage                         </td> <td> <b>giallo ambra</b>                              (opz.8225)                              amber                         </td> <td> <b>rosso corallo</b>                              (opz.8131)                              red coral                         </td> <td> <b>rosa quarzo</b>                              (opz.8171)                              quartz pink                         </td> </tr> </table>	<b>bianco assoluto</b> (opz.740) white absolute	<b>vulcano</b> (opz.9615) volcano	<b>bruno antilope</b> (opz.9541) brown antelope	<b>acquamarina</b> (opz.8323) aquamarine	<b>salvia</b> (opz.8443) sage	<b>giallo ambra</b> (opz.8225) amber	<b>rosso corallo</b> (opz.8131) red coral	<b>rosa quarzo</b> (opz.8171) quartz pink		
	<b>bianco assoluto</b> (opz.740) white absolute	<b>vulcano</b> (opz.9615) volcano		<b>bruno antilope</b> (opz.9541) brown antelope	<b>acquamarina</b> (opz.8323) aquamarine								
<b>salvia</b> (opz.8443) sage	<b>giallo ambra</b> (opz.8225) amber	<b>rosso corallo</b> (opz.8131) red coral	<b>rosa quarzo</b> (opz.8171) quartz pink										
L 13 P 7,5 H 10 W 13 D 7,5 H 10	08608757												

# ACCESSORI SOTTOPENSILI "IMPERO"

## "IMPERO" UNDER WALL UNIT ACCESSORIES

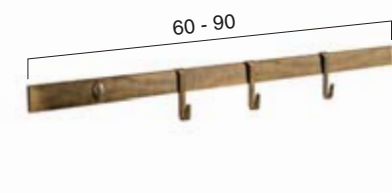
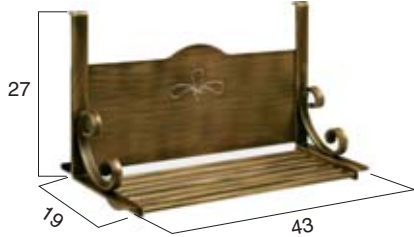
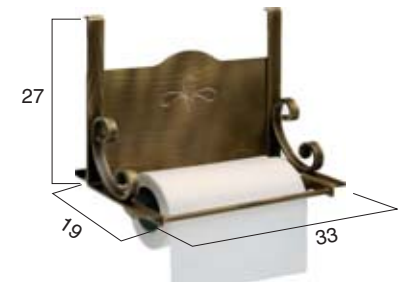
	<p><b>Portamestoli "IMPERO"</b>  <b>composto da:</b>  <b>1 barra cm 60 o da cm 90</b>  <b>3 ganci singoli</b>  <b>1 confezione di fissaggio</b></p> <p><b>Ottone antico</b>  L 60  L 90</p> <p><b>Argento antico</b>  L 60  L 90</p>	<p>"IMPERO" ladle holder inclusive of:  1 x 60 or 90 cm rod  3 single hooks  1 fixing set</p> <p><b>CODICE / CODE No.</b></p> <p><b>08600504</b>  <b>08600514</b></p> <p><b>08600505</b>  <b>08600515</b></p>	
	<p><b>Mensola portabarattoli "IMPERO"</b></p> <p><b>Ottone antico</b>  <b>Argento antico</b></p>	<p>"IMPERO" jar shelf</p> <p><b>08600564</b>  <b>08600565</b></p>	
	<p><b>Mensola portarotolo "IMPERO"</b></p> <p><b>Ottone antico</b>  <b>Argento antico</b></p>	<p>"IMPERO" tissue roll shelf</p> <p><b>08600554</b>  <b>08600555</b></p>	





# PIEDI PENISOLA

## PENINSULA FEET



	<p><b>Piede penisola regolabile</b> Adjustable peninsula foot</p> <p>Satinato Nero Ottone Anticato Argento Anticato</p> <p>Satin Black Antique Brass Antique Silver</p>	<p><b>CODICE / CODE No.</b></p> <p><b>08800250</b> <b>08800100</b> <b>08800260</b> <b>08800270</b></p>	
	<p><b>Piede penisola regolabile con piantana nera</b> Adjustable peninsula foot with black pedestal</p> <p>Cromo Alluminio</p> <p>Chrome Alu</p>	<p><b>08800005</b> <b>08800000</b></p>	
	<p><b>Piede kyros regolabile con piantana</b> kyros adjustable foot with pedestal</p> <p>Finitura Cromo Kyros (69-92) Kyros 2 (62-80)</p> <p>Chrome Finish Kyros (69-92) Kyros 2 (62-80)</p>	<p><b>08800015</b> <b>08800020</b></p>	
	<p><b>Gambone per penisola finitura cromo con piastra 20x20</b> Big foot for peninsula, chrome finish with plate 20x20</p> <p>cromo</p> <p>chrome</p>	<p><b>08790150</b></p>	
	<p><b>Gambone per penisola regolabile nelle finiture: cromo, anodizzato grigio, bianco, nero e brown</b> Big foot for peninsula, various finishes: chrome, anodised grey, white, black and brown</p> <p>cromo grigio bianco nero brown</p> <p>chrome grey white black brown</p>	<p><b>08790180</b> <b>08790181</b> <b>08790182</b> <b>08790183</b> <b>08790184</b></p>	
	<p><b>Gambone per penisola</b> Big foot for peninsula</p> <p>Finitura cromata L 063 H 75 L 079 H 75 L 121 H 75  L 063 H 84 L 079 H 84 L 121 H 84  L 063 H 87 L 079 H 87 L 121 H 87  L 063 H 88 L 079 H 88 L 121 H 88</p> <p>Chrome finish W 063 H 75 W 079 H 75 W 121 H 75  W 063 H 84 W 079 H 84 W 121 H 84  W 063 H 87 W 079 H 87 W 121 H 87  W 063 H 88 W 079 H 88 W 121 H 88</p>	<p><b>08790031</b> <b>08790032</b> <b>08790034</b>  <b>08790011</b> <b>08790012</b> <b>08790014</b>  <b>08790015</b> <b>08790016</b> <b>08790018</b>  <b>08790041</b> <b>08790042</b> <b>08790044</b></p>	

# ACCESSORI PER MENSOLE

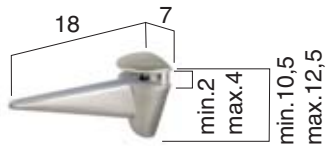
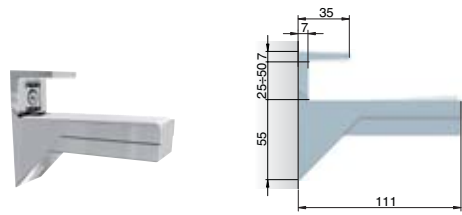
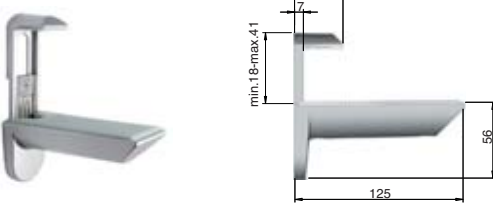

## SHELF ACCESSORIES

	<p><b>Reggimensola a scomparsa</b> Fully integrated shelf bracket</p> <p>cadauno (pc)</p>	<p><b>CODICE / CODE No.</b></p> <p><b>08610400</b></p>	
	<p><b>Reggimensola ad angolo</b> Corner shelf bracket</p> <p>Bianco Nero White Black</p>	<p><b>08610360</b> <b>08610350</b></p>	
	<p><b>Reggimensola "RMFL"</b> "RMFL" shelf bracket</p> <p>nichel satinato cad. cromo cadauno satin nickel (each) chrome (each)</p>	<p><b>08610485</b> <b>08610487</b></p>	
	<p><b>Reggimensola in metallo per mensole in laminato</b> Corner shelf Metal shelf bracket for laminate shelves, thickness sp.3,8 - prof. 31 - 34,5 3.8 - depth 31 - 34.5</p> <p>brill cadauno brill each</p>	<p><b>08610491</b></p>	
	<p><b>reggimensola kalabrone</b> kalabrone shelf bracket (capacity portata 25 kg per reggimensola con mensola prof. 31) 25 kg per bracket with 31 cm deep shelf)</p> <p>confezione da 2 pezzi nichel satinato cromo Pack of 2 pcs satin nickel chrome</p>	<p><b>08610435</b> <b>08610436</b></p>	
	<p><b>reggimensola kaiman</b> kaiman shelf bracket (capacity portata 25 kg per reggimensola con mensola prof. 31) 25 kg per bracket with 31 cm deep shelf) min. 18 max. 41</p> <p>confezione da 2 pezzi nichel satinato cromo Pack of 2 pcs satin nickel chrome</p>	<p><b>08610437</b> <b>08610438</b></p>	

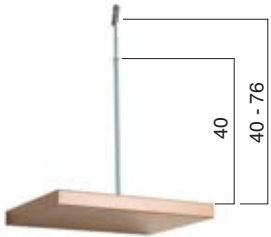
## ACCESSORI PER MENSOLE SHELF ACCESSORIES

	<p><b>Reggimensola ad angolo</b> Corner shelf bracket</p> <p>argento anticato cadauno ottone anticato cadauno</p> <p>antique silver (each) antique brass (each)</p>	<p><b>CODICE / CODE No.</b></p> <p><b>08610385</b> <b>08610380</b></p>	
	<p><b>Mensola in cristallo con reggimensola finitura champagne</b> Glass shelf with champagne-coloured shelf brackets</p> <p><b>Reggimensola cad. Men.cristallo sp.1 prof.25 al ml</b> Shelf bracket (each) Glass shelf thickness 1 depth 25 (per m)</p>	<p><b>08610480</b> <b>091537</b></p>	
	<p><b>Reggimensola "Quick" regolabile per mensola soprapenisola</b> "Quick" adjustable shelf bracket for over peninsula shelf</p> <p><b>Ottone Antico Cromo Satinato</b> Antique Brass Satin Chrome</p>	<p><b>08610325</b> <b>08610327</b></p>	

# RIPIANI SHELVES

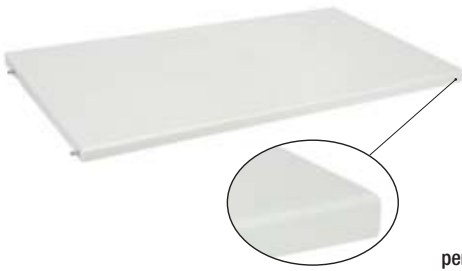
	<p><b>maggiorazioni per ripiani in vetro (opz.990)</b></p> <p>surcharges for glass shelves (code 990)</p> <p><b>per pensile</b> L 45 L 60 L 90</p> <p><b>per colonna</b> L 45 L 60 L 90</p>	<p><b>CODICE / CODE No.</b></p>	
	<p><b>Ripiani in vetro (opz.900) con supporti</b></p> <p>Glass shelves (code 900) with brackets</p> <p><b>per pensile P.33 (28)</b> L 045 L 060 L 090</p> <p><b>per base e colonna P.60 (50)</b> L 045 L 060 L 090</p>	<p>for wall unit W 45 W 60 W 90</p> <p>for wall unit depth 33 (28) W 045 W 060 W 090</p> <p>for column W 45 W 60 W 90</p> <p>for column depth 60 (50) W 045 W 060 W 090</p> <p><b>4361040</b> <b>4361050</b> <b>4361070</b></p> <p><b>4362040</b> <b>4362050</b> <b>4362070</b></p>	
	<p><b>Ripiani in nobilitato con supporti bianco (opz.001) avorio (opz.930)</b></p> <p>Coated shelves with brackets white (code 001) ivory (code 930)</p> <p><b>per pensile P.33 (28)</b> L 015 L 030 L 040 L 045 L 060 L 080 L 090</p> <p><b>angolo diagonale 65x65</b> <b>angolo libretto 65x65</b></p> <p><b>per base e colonna P.60 (50)</b> L 030 L 040 L 045 L 060 L 080 L 090 L 105</p>	<p>for wall unit depth 33 (28) W 015 W 030 W 040 W 045 W 060 W 080 W 090</p> <p>diagonal corner 65x65 folding corner 65x65</p> <p>for base and column depth 60 (50) W 030 W 040 W 045 W 060 W 080 W 090 W 105</p> <p><b>4310010</b> <b>4310020</b> <b>4310030</b> <b>4310040</b> <b>4310050</b> <b>4310060</b> <b>4310070</b> <b>4330030</b> <b>4330035</b></p> <p><b>4355020</b> <b>4355030</b> <b>4355040</b> <b>4355050</b> <b>4355060</b> <b>4355070</b> <b>4355090</b></p>	

## NUOVE CERNIERE NEW HINGES

Tutte le nuove cerniere sono **ammortizzate di serie**  
All new hinges are **fitted with shock-absorbers as standard equipment**

# CERNIERA APERTURA 110° AMMORTIZZATA HINGE, ANGLE 110°, SHOCK-ABSORBER

(cod./code **5643101**)



**Ammortizzatore integrato**  
Integrated shock-absorber



L'ammortizzatore sulla nuova cerniera può essere **disattivato** agendo sull'apposito selettore. È possibile in questo modo regolare la chiusura ammortizzata a seconda della dimensione dell'anta, peso e n° di cerniere.

Link filmato: <http://www.lubeservice.it/spot/cerniera-ammortizzata-BLUM.wmv>

The shock-absorber on the new hinge can be disabled with a switch. This enables the user to adjust the shock absorbing function to the size and weight of the panel and the number of hinges used.

Video link: <http://www.lubeservice.it/spot/cerniera-ammortizzata-BLUM.wmv>

Le nuove cerniere sono anche **clip** ed hanno tutte la **regolazione verticale della basetta e quindi dell'anta con vite ed eccentrico**:

The new hinges are also **clip-on** and all have **vertical adjustment of the base plate (and hence the panel) with a screw and cam system**:

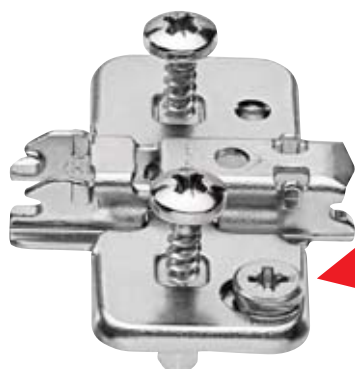

**Vite per regolazione verticale**  
Vertical adjuster screw

## NUOVA BASETTA CLIP NEW CLIP-ON BASE PLATE

(cod./code **5648010**)

**Anche tutte le altre regolazioni delle cerniere si effettueranno tramite vite ed eccentrico**

All other hinge adjustments are also done with a screw and cam system



## CERNIERE CLIP CLIP-ON HINGES

cerniera normale 110° con  
ammortizzatore integrato  
standard 110° hinge with integrated shock-absorber



(cod. /code 5643101)

cerniera 135° con ammortizzatore  
integrato (per angolo pensile in diagonale)  
135° hinge with integrated shock-absorber  
(for diagonal corner wall unit)



(cod./code 5643105)

cerniera pilastro con ammortizzatore  
integrato (per basi angolo)  
pillar hinge with integrated shock-absorber  
(for corner base units)



(cod. /code 5643107)

cerniera 155° è anche a protusione 0 e quindi  
utilizzabile per le ante con i cassetti interni  
155° hinge with 0 protrusion, thus also suited to use with internal  
drawers

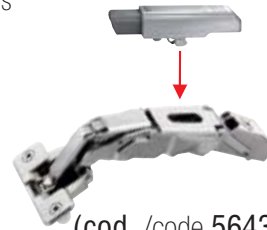

ammortizzatore ad aggancio  
Hook-on shock-absorber

(cod./code 5646103)

cerniera per telaio alluminio 20x20 mm  
hinge for aluminium frame 20x20 mm

ammortizzatore ad aggancio  
Hook-on shock-absorber

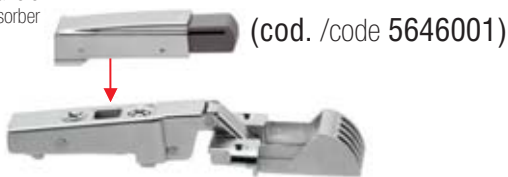

(cod. /code 5645001)



basetta per cerniere clip / base plate for clip-on hinge



(cod. /code 5648010)

## CERNIERE FRIGO REFRIGERATOR HINGES

**NON** sono ammortizzate  
**NOT** soft-closing



(cod. /code 5643109)

La basetta **NON** è CLIP, ma è  
avvitata e compresa sulla cerniera.  
Le regolazioni sono spostate per  
permettere il loro facile accesso  
con il frigo montato.

The base plate is **NOT** clip-on, but bolt-  
on, and forms part of the hinge itself.  
The adjustments are offset to permit  
easy access with the refrigerator already  
installed.



# ACCESSORI

## ACCESSORIES

	<p><b>Barra reggipensili da 2 mt</b>      Wall unit support bar, 2 m</p> <p>cadauna      each</p>	<p><b>CODICE / CODE No.</b></p> <p><b>08610501</b></p>	
	<p><b>Tirante per pensile 90</b>      Tie-rod or wall unit 90</p> <p>Pensile      Wall unit height</p> <p>H 36      H 36      <b>5620900</b></p> <p>H 48      H 48      <b>5620905</b></p> <p>H 60      H 60      <b>5620907</b></p> <p>H 72      H 72      <b>5620909</b></p> <p>H 96      H 96      <b>5620911</b></p> <p>H 120      H 120      <b>5620914</b></p> <p>H 132      H 132      <b>5620916</b></p> <p>Colonna      Column</p> <p>H 204      H 204      <b>5620920</b></p>		
<p><b>1 via</b> <b>1 way</b></p>  <p><b>2 vie</b> <b>2 way</b></p>  <p><b>Salvaspazio 2 vie</b> <b>2 way space-saver</b></p> 	<p><b>Ricambio sifone con attacco lavastoviglie</b>      Spare drain pipe with dishwasher fitting</p> <p>1 via      1 way</p> <p>2 vie      2 way</p> <p><b>Salvaspazio 2 vie</b>      2 way space-saver</p>	<p><b>08711200</b></p> <p><b>08711210</b></p> <p><b>08711260</b></p>	
	<p><b>Protezione per base sottolavello</b>      Protection for sink base unit</p> <p>L 045      W 045      <b>5590001</b></p> <p>L 060      W 060      <b>5590002</b></p> <p>L 080      W 080      <b>5590003</b></p> <p>L 090      W 090      <b>5590004</b></p> <p>L 120      W 120      <b>5590005</b></p> <p>L 95x95      W 95x95      <b>5590018</b></p> <p>L 110x110      W 110x110      <b>5590019</b></p>		
	<p><b>Portabottiglie cromato con fissaggio a parete</b>      Chromed bottle holder for wall installation</p> <p>L 27 H 47 P 25      W 27 H 47 D 25</p> <p><b>N.B.: esempio foto con nr. 3 moduli</b>      <b>N.B.: example in picture with 3 modules</b></p> <p>cadauno      each</p>	<p><b>08703200</b></p>	

## PLACCHE DI COPERTURA PER MECCANISMI (RICAMBI)

### MECHANISM COVER PLATES (REPLACEMENT)

	<p>Placca per meccanismo apertura verticale obliqua</p>	<p>Cover plate for oblique vertical opening mechanism</p>	<p><b>CODICE / CODE No.</b></p>	
	<p>Placca Dx</p>	<p>RH plate</p>	<p><b>5619121</b></p>	
	<p>Placca Sx</p>	<p>LH plate</p>	<p><b>5619122</b></p>	
	<p>Placca per meccanismo apertura verticale</p>	<p>Cover plate for vertical opening mechanism</p>		
	<p>Placca Dx</p>	<p>RH plate</p>	<p><b>5619111</b></p>	
	<p>Placca Sx</p>	<p>LH plate</p>	<p><b>5619112</b></p>	
	<p>Placca per meccanismo apertura a pacchetto</p>	<p>Cover plate for folding opening mechanism</p>		
	<p>Placca Dx</p>	<p>RH plate</p>	<p><b>5619115</b></p>	
	<p>Placca Sx</p>	<p>LH plate</p>	<p><b>5619116</b></p>	

## ACCESSORI PER CASSETTI E CESTONI

### ACCESSORIES FOR DRAWERS AND DEEP DRAWERS

	<p>Placchetta per cassetto</p>	<p>Drawer plaque</p>	<p><b>CODICE / CODE No.</b></p>	
				
	<p>cadauna</p>	<p>each</p>	<p><b>5730461</b></p>	